

a mathematical history of taffy pullers

Jean-Luc Thiffeault

Department of Mathematics
University of Wisconsin – Madison

Arts & Science Lecture
Clarkson University
20 November 2015

Supported by NSF grant CMMI-1233935



WISCONSIN
UNIVERSITY OF WISCONSIN-MADISON

the taffy puller



Taffy is a type of candy.

Needs to be **pulled**: this aerates it and makes it lighter and chewier.

We can assign a **growth**: length multiplier per period.

[movie by M. D. Finn]

play movie



making candy cane



[*Wired*: This Is How You Craft 16,000 Candy Canes in a Day]

four-pronged taffy puller



play movie

<http://www.youtube.com/watch?v=Y7t1HDSquVM>

[MacKay (2001); Halbert & Yorke (2014)]

a simple taffy puller



initial

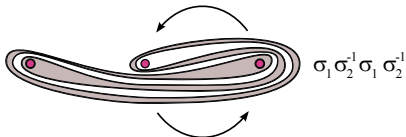
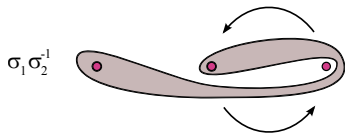
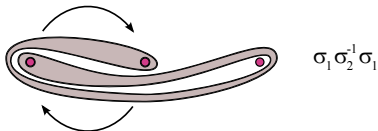
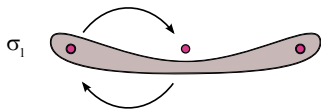

[Remark for later: each rod moves in a 'figure-eight' shape.]

the famous mural



This is the same action as in the famous mural painted at Berkeley by Thurston and Sullivan in the Fall of 1971:

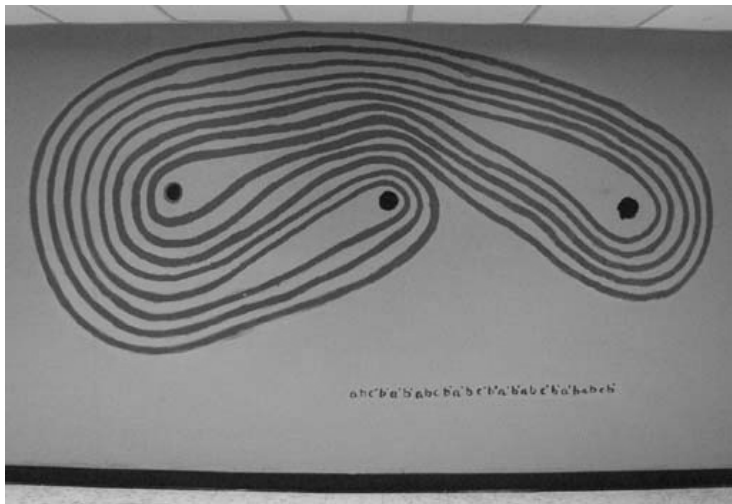



[Matlab: demo1]

Let's count alternating left/right folds. The sequence is

$$\#folds = 1, 1, 2, 3, 5, 8, 13, 21, 34, \dots$$

What is the rule?

$$\#folds_n = \#folds_{n-1} + \#folds_{n-2}$$

This is the famous **Fibonacci sequence**, F_n .

how fast does the taffy grow?



It is well-known that for large n ,

$$\frac{F_n}{F_{n-1}} \rightarrow \phi = \frac{1 + \sqrt{5}}{2} = 1.6180\dots$$

where ϕ is the **Golden Ratio**, also called the **Golden Mean**.

So the ratio of lengths of the taffy between two successive steps is ϕ^2 , where the squared is due to the left/right alternation.

Hence, the **growth factor** for this taffy puller is

$$\phi^2 = \phi + 1 = 2.6180\dots$$

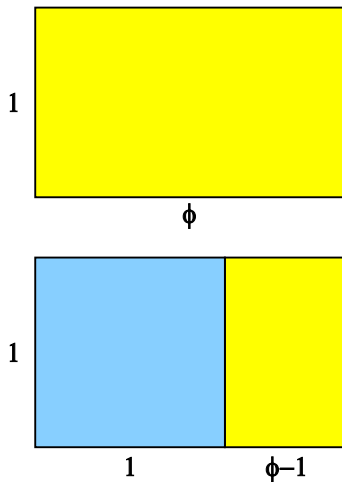

A rectangle has the proportions of the Golden Ratio if, after taking out a square, the remaining rectangle has the same proportions as the original:

$$\frac{\phi}{1} = \frac{1}{\phi - 1}$$

a slightly more complex taffy puller



[Matlab: demo2]

Now let's swap our prongs twice each time.

We get for the number of left/right folds

$$\#folds = 1, 2, 5, 12, 29, 70, 169, 408 \dots$$

This sequence is given by

$$\#folds_n = 2\#folds_{n-1} + \#folds_{n-2}$$

For large n ,

$$\frac{\#folds_n}{\#folds_{n-1}} \rightarrow \chi = 1 + \sqrt{2} = 2.4142 \dots$$

where χ is the **Silver Ratio**, a much less known number.

Hence, the **growth factor** for this taffy puller is

$$\chi^2 = 2\chi + 1 = 5.8284 \dots$$

the Silver Ratio, χ



A rectangle has the proportions of the Silver Ratio if, after taking out **two squares**, the remaining rectangle has the same proportions as the original.

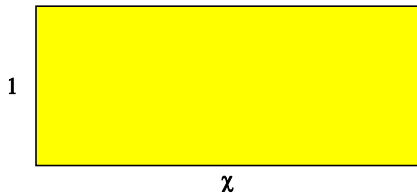

$$\frac{\chi}{1} = \frac{1}{\chi - 2}$$

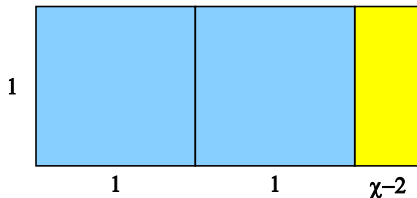

Both major taffy puller designs (3- and 4-rod) have growth χ^2 .

These quadratic numbers are reminiscent of invertible linear maps on the torus T^2 , such as **Arnold's Cat Map**:

$$\begin{pmatrix} x \\ y \end{pmatrix} \mapsto \begin{pmatrix} 2 & 1 \\ 1 & 1 \end{pmatrix} \begin{pmatrix} x \\ y \end{pmatrix} \pmod{1}, \quad x, y \in [0, 1]^2$$

The largest eigenvalue of the matrix

$$M = \begin{pmatrix} 2 & 1 \\ 1 & 1 \end{pmatrix}$$

is ϕ^2 .

What's the connection between taffy pullers and these maps?

The 'standard model' for the torus is the biperiodic unit square:

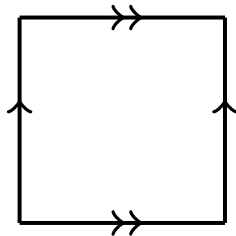
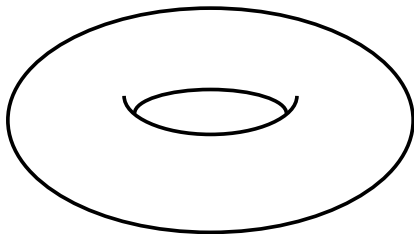

The Cat Map stretches loops exponentially:

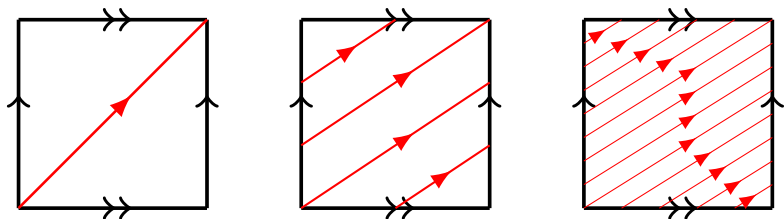

This loop will stand in for a piece of taffy.

hyperelliptic involution



Consider the linear map $\iota(x) = -x \bmod 1$. This map is called the **hyperelliptic involution** ($\iota^2 = \text{id}$).

Construct the quotient space

$$S = T^2 / \iota$$

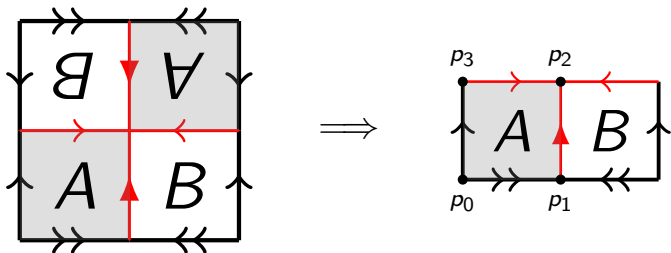

Claim: the surface S (right) is a sphere with four **punctures**!

sphere with four punctures



Here's how we see that S is a sphere:

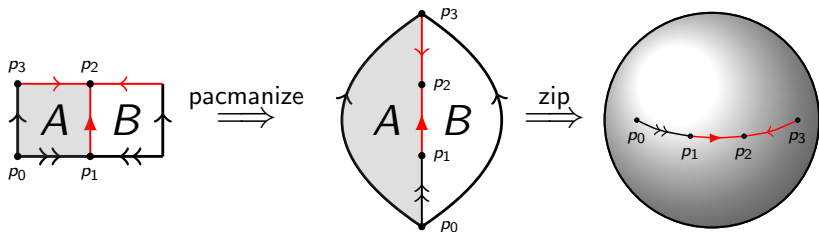

The punctures $p_{1,2,3}$ are the **rods of our taffy puller**. The puncture p_0 is like a point at infinity on the plane.

Linear maps **commute with ι** , so all linear torus maps 'descend' to taffy puller motions.

Any taffy puller motion can be represented as a product of

$$\sigma_1 = \begin{pmatrix} 1 & 0 \\ 1 & 1 \end{pmatrix}, \quad \sigma_2 = \begin{pmatrix} 1 & -1 \\ 0 & 1 \end{pmatrix}$$

and their inverses, known as **Dehn twists**.

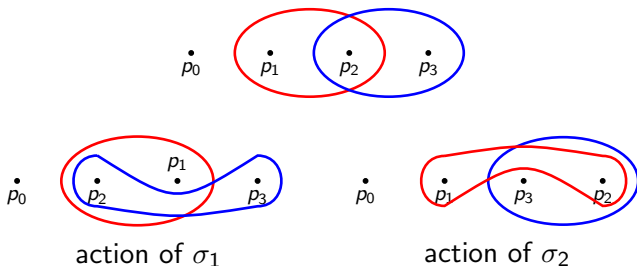

These can also be view as generators for the **braid group** for 3 strings.

the history of taffy pullers



This past Summer I started wondering about who invented the well-known designs for taffy pullers. [Google patents](#) is an awesome resource.

The very first: Firchau (1893)

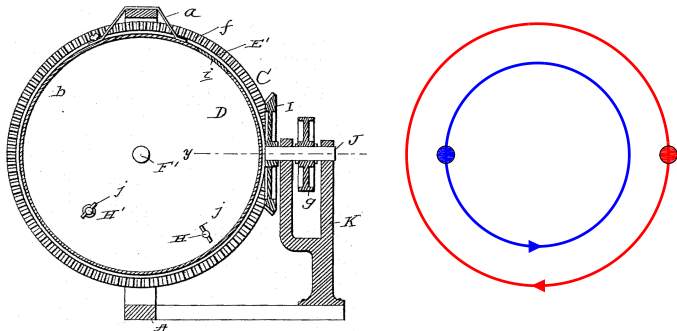

This is a terrible taffy puller. It was likely never built, but plays an important role in the looming...

A black and white photograph showing a large fleet of aircraft carriers and their escorts at sea. The carriers are positioned in a line across the bottom of the frame. Above them, a vast formation of aircraft, likely F4U Corsairs, is flying in a complex, multi-tiered pattern that fills most of the sky. The text "taffy patent wars" is overlaid in red in the center of the image.

taffy patent wars

The first true taffy puller



I think Dickinson (1906, but filed in 1901) deserves the title of inventor of the first taffy puller:

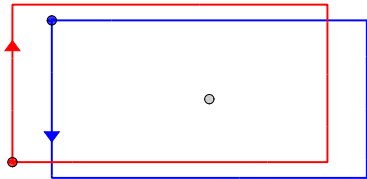
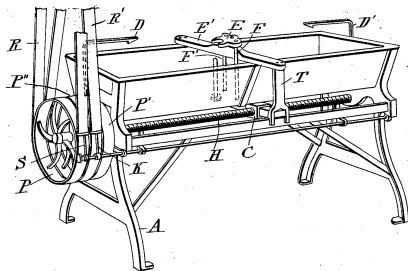

Awkward design: the moving rods get 'tripped' each cycle. But it is topologically the same as the 3-rod device still in use today.

There seem to be questions as to whether it ever worked, or if it really pulled taffy rather than mixing candy.

The modern 3-rod design



Robinson & Deiter (1908) greatly simplified this design to one still in use today.

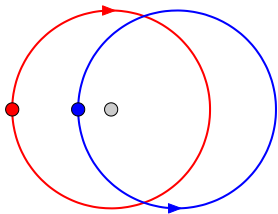
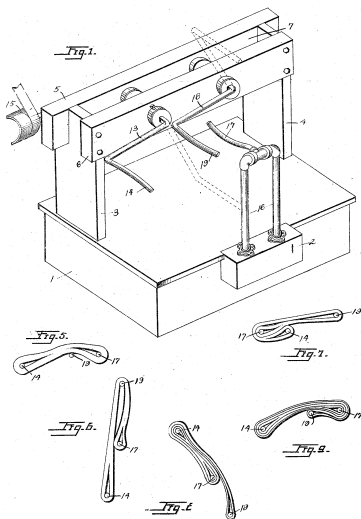

The uncontested taffy magnate of the early 20th century was Herbert L. Hildreth of Maine.



The Hotel Velvet in Old Orchard, Maine

His hotel was on the beach, and taffy was popular at such resorts. He sold it wholesale as well.

**Hildreth's Original
— and Only —
Velvet Candy**

Is now put up in Triple Sealed Packages. Moisture, Germ and Dust Proof

For sale by the Jobbing trade everywhere. Send for Price List and Samples. The finest seller on earth. Has been on the market nearly 25 years. Nothing like it. Address

H. L. HILDRETH CO.
Franklin and Battery-march Sts.
Boston, Mass.

The Confectioners Gazette (1914)

the 4-rod design



The first 4-rod design is by Thibodeau (1903, filed 1901), an employee of Hildreth.

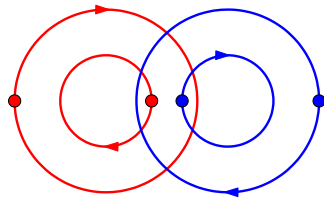
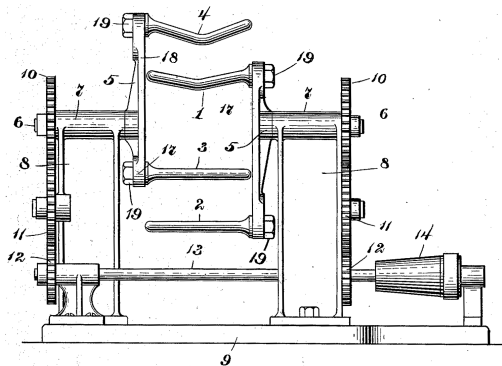

Hildreth was not pleased by this but bought the patent for \$75,000 (about two million of today's dollars).

the best patents have beautiful diagrams

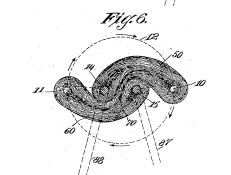
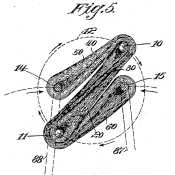
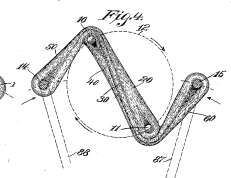
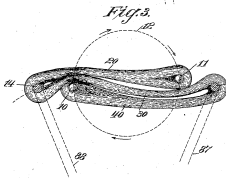
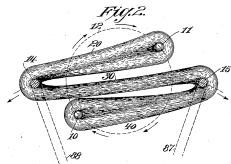
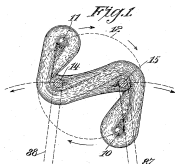
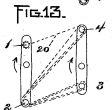
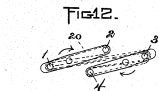
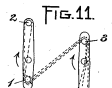
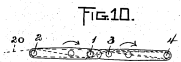
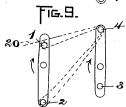
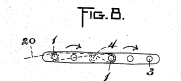
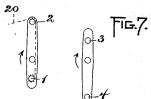
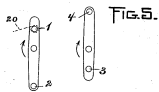
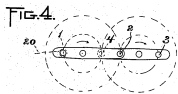

Thibodeau (1903)

Richards (1905)



So many concurrent patents were filed that lawsuits ensued for more than a decade. Shockingly, the taffy patent wars went all the way to the **US Supreme Court**. The opinion of the Court was delivered by **Chief Justice William Howard Taft** (*Hildreth v. Mastoras*, 1921):

*The machine shown in the Firchau patent [has two pins that] pass each other twice during each revolution [...] and move in concentric circles, but do not have the relative in-and-out motion or Figure 8 movement of the Dickinson machine. With only two hooks there could be no lapping of the candy, because there was no third pin to re-engage the candy while it was held between the other two pins. The movement of the two pins in concentric circles might stretch it somewhat and stir it, **but it would not pull it in the sense of the art.***

The Supreme Court opinion displays the fundamental insight that at least three rods are required to produce some sort of rapid growth.

the quest for the Golden ratio



Is it possible to build a device that realizes the **simplest taffy puller**, with growth ϕ^2 ?

The problem is that each rod **moves in a Figure-eight!** This is hard to do mechanically.

After some digging, found the patent of Nitz (1918):

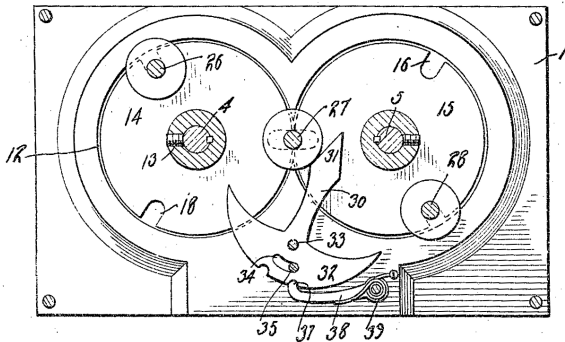

the quest for the Golden ratio (2)



There is actually an earlier 4-rod design by Thibodeau (1904) which has Golden ratio growth:

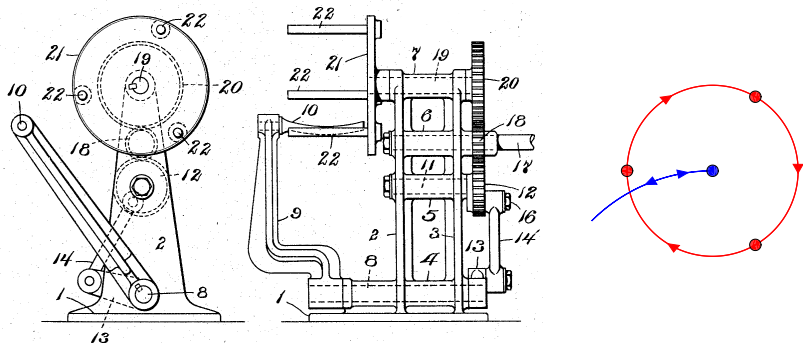

Since it uses four rods to get a quadratic growth, the map must involve a **branched cover of the torus** by a theorem of Franks & Rykken (1999). (The same happens for the 4-rod vs 3-rod 'standard' taffy pullers.)

the quest for the Golden ratio (3)

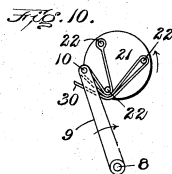
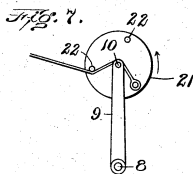
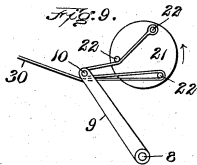
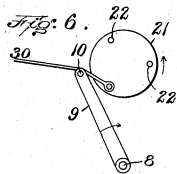
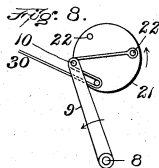
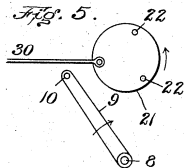

Thibodeau (1904) once again gives very nice diagrams for the action of his taffy puller.

(He has at least 5 patents for taffy pullers.)

A few designs are based on 'planetary' gears, such as McCarthy (1916):

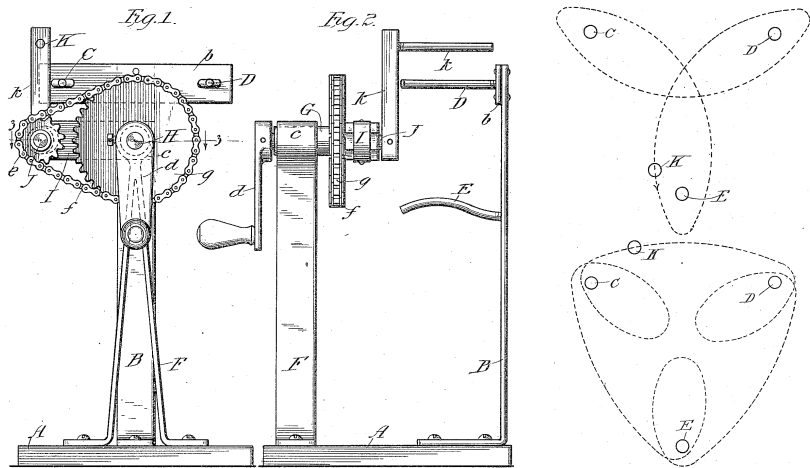

the mixograph



A modern planetary design is the **mixograph**, a device for measuring the properties of dough:

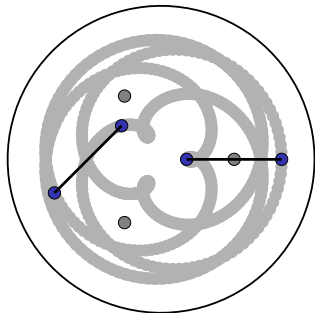

play movie

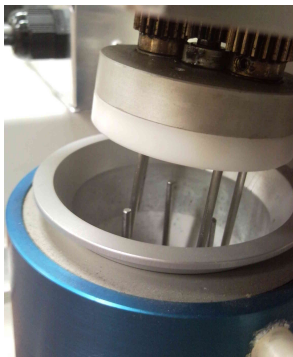

[Department of Food Science, University of Wisconsin. Photos by J-LT.]



The mixograph measures the resistance of the dough to the pin motion.

This is graphed to determine properties of the dough, such as water absorption and 'peak time.'

the mixograph as a braid



Encode the topological information as a sequence of **generators of the Artin braid group B_n** .

Equivalent to the 7-braid

$$\sigma_3 \sigma_2 \sigma_3 \sigma_5 \sigma_6^{-1} \sigma_2 \sigma_3 \sigma_4 \sigma_3 \sigma_1^{-1} \sigma_2^{-1} \sigma_5$$

We feed this braid to the **Bestvina–Handel algorithm**, which determines the **Thurston type** of the braid (**pseudo-Anosov**) and finds the **growth** as the largest root of

$$x^8 - 4x^7 - x^6 + 4x^4 - x^2 - 4x + 1$$

$$\simeq 4.186$$

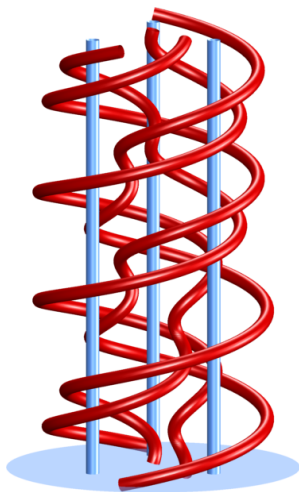

As part of an optimization procedure, we (Finn & Thiffeault, 2011) designed a family of planetary mixers with **silver ratio** expansion:

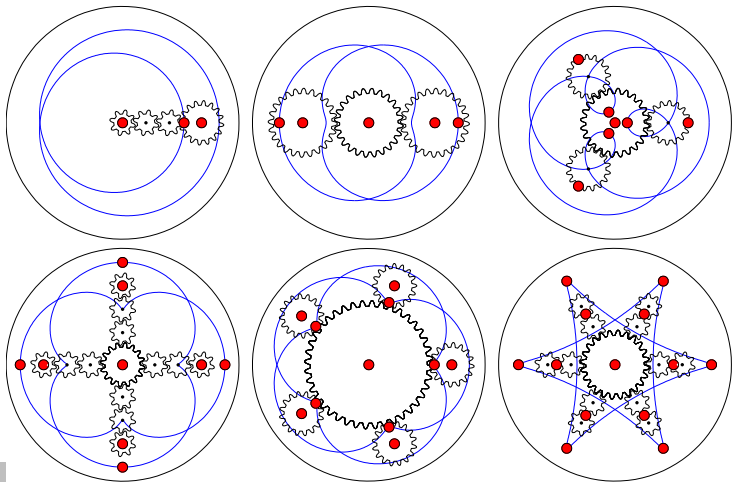

play movie



play movie

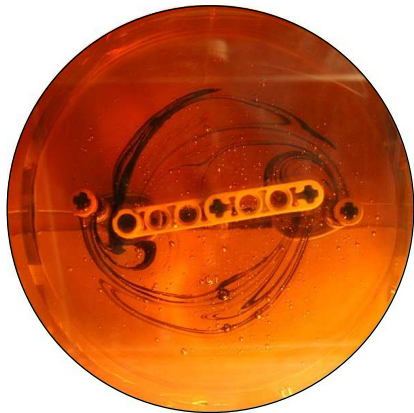

play movie

[See Finn, M. D. & Thiffeault, J.-L. (2011). *SIAM Rev.* **53** (4), 723–743 for proofs, heavily influenced by work on π_1 -stirrers of Boyland, P. L. & Harrington, J. (2011). *Algeb. Geom. Topology*, **11** (4), 2265–2296.]

There remains many patents that I call 'exotic' which use nonstandard motions: such as Jenner (1905):

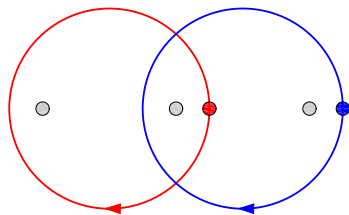
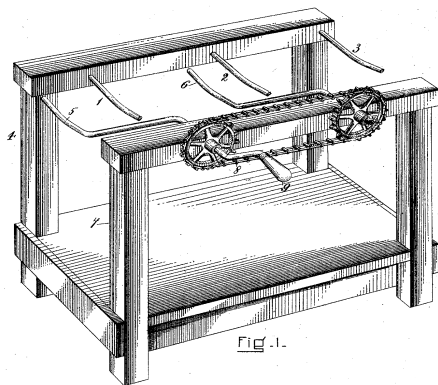

Shean & Schmelz (1914):

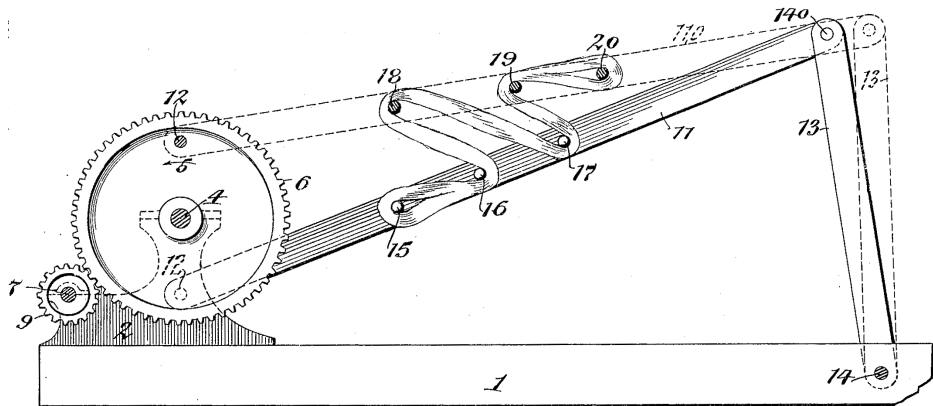

exotic designs (3)



My personal favorite, McCarthy & Wilson (1915):

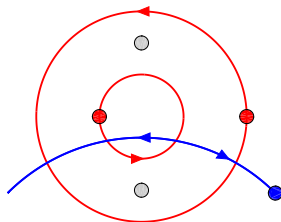
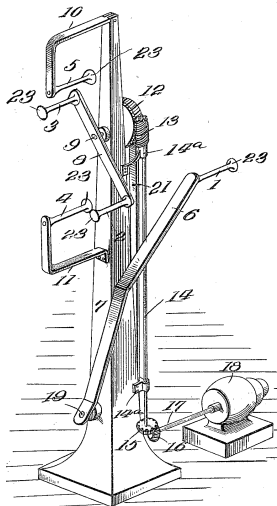

let's try our hand at this



Six-rod design with Alex Flanagan:

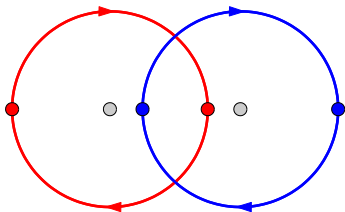
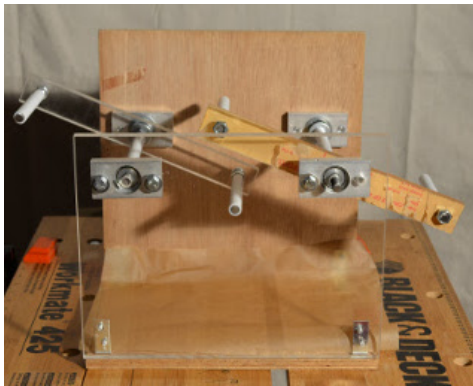

The software tools allow us to rapidly try designs. This one is simple and has huge growth (13.9 vs 5.8 for the standard pullers).

making taffy is hard



Early efforts yielded mixed results: . . . but eventually we got better at it

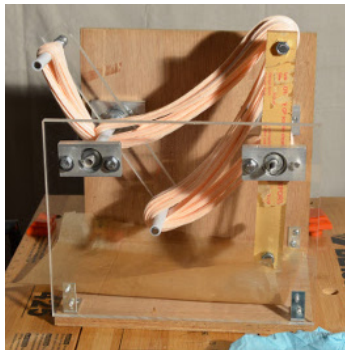
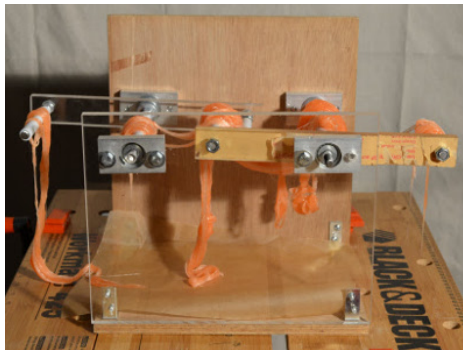

play movie

(BTW: The physics of candy making is fascinating. . .)



- My real interest is in fluid mixing, in particular of viscous substances.
- Mixing is a **combinatorial process**, akin to **shuffling**.
- The taffy designs also pop up in 'serious' **chemical mixers**.
- The topological dynamics methods pioneered by Thurston allows us to understand these rod motions in great detail.
- For example, in addition to the growth, there is a **measure** that tells us how taffy is distributed on the rods.
- **pseudo-Anosov maps** themselves are still the subject of intense study).



- Allshouse, M. R. & Thiffeault, J.-L. (2012). *Physica D*, **241** (2), 95–105.
- Bestvina, M. & Handel, M. (1995). *Topology*, **34** (1), 109–140.
- Binder, B. J. & Cox, S. M. (2008). *Fluid Dyn. Res.* **40**, 34–44.
- Boyland, P. L., Aref, H., & Stremler, M. A. (2000). *J. Fluid Mech.* **403**, 277–304.
- Boyland, P. L. & Harrington, J. (2011). *Algeb. Geom. Topology*, **11** (4), 2265–2296.
- Boyland, P. L., Stremler, M. A., & Aref, H. (2003). *Physica D*, **175**, 69–95.
- D'Alessandro, D., Dahleh, M., & Mezić, I. (1999). *IEEE Transactions on Automatic Control*, **44** (10), 1852–1863.
- Dickinson, H. M. (1906). Cooperative Classification A23G3/10.
- Finn, M. D. & Thiffeault, J.-L. (2011). *SIAM Rev.* **53** (4), 723–743.
- Firchau, P. J. G. (1893). Cooperative Classification B01F7/166.
- Franks, J. & Rykken, E. (1999). *Proc. Amer. Math. Soc.* **127**, 2183–2192.
- Gouillart, E., Finn, M. D., & Thiffeault, J.-L. (2006). *Phys. Rev. E*, **73**, 036311.
- Halbert, J. T. & Yorke, J. A. (2014). *Topology Proceedings*, **44**, 257–284.
- Handel, M. (1985). *Ergod. Th. Dynam. Sys.* **8**, 373–377.
- Jenner, E. J. (1905). Cooperative Classification A23G3/10.



- Kobayashi, T. & Umeda, S. (2007). In: *Proceedings of the International Workshop on Knot Theory for Scientific Objects, Osaka, Japan* pp. 97–109, Osaka, Japan: Osaka Municipal Universities Press.
- Lin, Z., Doering, C. R., & Thiffeault, J.-L. (2011). *J. Fluid Mech.* **675**, 465–476.
- MacKay, R. S. (2001). *Phil. Trans. R. Soc. Lond. A*, **359**, 1479–1496.
- Mathew, G., Mezić, I., & Petzold, L. (2005). *Physica D*, **211** (1-2), 23–46.
- McCarthy, E. F. (1916). U.S. Classification 366/70; Cooperative Classification A23G3/10.
- McCarthy, E. F. & Wilson, E. W. (1915). U.S. Classification 366/70; Cooperative Classification A23G3/10.
- Moussafir, J.-O. (2006). *Func. Anal. and Other Math.* **1** (1), 37–46.
- Nitz, C. G. W. (1918). U.S. Classification 366/70; Cooperative Classification A23G3/10.
- Richards, F. H. (1905). Cooperative Classification A23G3/42.
- Robinson, E. M. & Deiter, J. H. (1908). Cooperative Classification A23G3/10.
- Shean, G. C. C. & Schmelz, L. (1914). U.S. Classification 366/70; Cooperative Classification A23G3/10.
- Stremler, M. A. & Chen, J. (2007). *Phys. Fluids*, **19**, 103602.
- Thibodeau, C. (1903). Cooperative Classification A23G3/42.
- Thibodeau, C. (1904). Cooperative Classification A23G3/10.



- Thiffeault, J.-L. (2005). *Phys. Rev. Lett.* **94** (8), 084502.
- Thiffeault, J.-L. (2012). *Nonlinearity*, **25** (2), R1–R44.
- Thiffeault, J.-L. & Finn, M. D. (2006). *Phil. Trans. R. Soc. Lond. A*, **364**, 3251–3266.
- Thiffeault, J.-L., Finn, M. D., Gouillart, E., & Hall, T. (2008). *Chaos*, **18**, 033123.
- Thurston, W. P. (1988). *Bull. Am. Math. Soc.* **19**, 417–431.
- Tumasz, S. E. & Thiffeault, J.-L. (2013). *J. Nonlinear Sci.* **13** (3), 511–524.