

The Theory of Normal Surfaces

based on Lecture Notes by Cameron McA. Gordon
typeset by Autumn Kent

1 Introduction

When one considers questions like:

When are two n -manifolds homeomorphic?

When are two groups isomorphic?

When are two knots equivalent?

When is a knot trivial?

the question usually arises: Decidable? Solvable?

Church Turing Thesis. *All intuitive notions of (effective, algorithmic) computability are equivalent to computability by a Turing machine.*

(A Turing machine operates according to a **finite** set of rules.)

Definition. A function $f : \mathbb{N} \rightarrow \mathbb{N}$ is *computable* if and only if there exists an algorithm which takes an arbitrary $n \in \mathbb{N}$ and produces $f(n)$, i.e. there exists a Turing machine M such that given input $n \in \mathbb{N}$, M halts with output $f(n)$.

Definition. $A \subset \mathbb{N}$ is *listable* (recursively enumerable) if there exists an algorithm which lists the elements of A : a_1, a_2, \dots (possibly repeating)—i.e. there exists a computable $f : \mathbb{N} \rightarrow \mathbb{N}$ with $\text{Im}(f) = A$.

Definition. $A \subset \mathbb{N}$ is *decidable* (recursive) if there exists an algorithm to decide whether or not an arbitrary $n \in \mathbb{N}$ belongs to A .

So, A is decidable $\iff A$ and $\mathbb{N} - A$ are listable \iff the characteristic function of A is computable.

EXAMPLES:

- (1) The set of primes is decidable.
- (2) Any finite set $A \subset \mathbb{N}$ is decidable.

These definitions carry over to $A \subset \mathbb{N}^n$ or \mathbb{Z}^n . More generally, let S be any (countable) set of objects, each decidable by a finite amount of numerical data, i.e. an element of \mathbb{Z}^n .

- { Finite presentations $\langle X : R \rangle$ of groups }
- { Finite simplicial complexes }:
- vertices $\longleftrightarrow \{1, 2, \dots, n\} = V$
- 1-simplices $\longleftrightarrow \{(i_1, i_2), \dots\} \subset V \times V$
- ...

Say S is *listable* if corresponding set in \mathbb{Z}^n is. If S is listable, $A \subset S$ is *decidable* if A and $S - A$ are listable.

Basic fact: There exists $S \subset \mathbb{N}$ which is listable but not decidable (Follows from the undecidability of the halting problem for Turing machines, which follows from ‘‘Russell’s Paradox’’). This leads to the undecidability, unsolvability, of many questions.

EXAMPLES:

(1) Let $P = \langle X : R \rangle$ be a finite presentation of a group G . Let $W = \{\text{words in } X\}$. W is listable. Let $T = \{w \in W : w = 1 \in G\} \subset W$. The Word Problem for P is: Is $T \subset W$ decidable?

Note: (i) The answer depends only on G (exercise).

(ii) T is listable.

There exist finite groups with unsolvable word problem (Novikov; Boone:1955).

(2) Let $S = \{\text{Finite presentations of groups}\}$. Then S is listable (Therefore $S \times S$ is listable). The Isomorphism Problem for finitely presented groups is: Is there an algorithm to decide for arbitrary $P_1, P_2 \in S$, whether or not the corresponding groups $G(P_1), G(P_2)$ are isomorphic, i.e. is $\{(P_1, P_2) \in S \times S : G(P_1) \cong G(P_2)\} \subset S \times S$ decidable? The answer is NO (Question: Is it listable?)

(3) S as in (2). Let $T = \{P \in S : G(P) = 1\} \subset S$ Is T decidable? Answer: NO. (T is listable (exercise)).

(4) A (closed) PL n -manifold M is $|K|$, K finite simplicial complex such that for all vertices v of K , the *simplicial neighborhood* (star) of v in $|K|$ is

simplicially isomorphic to the cone on (some subdivision of $\partial\Delta^n$), where Δ^n is the standard n -simplex.

Two such $M_1 = |K_1|$ and $M_2 = |K_2|$ are PL-homeomorphic if and only if K_1 and K_2 have simplicially isomorphic subdivisions.

[Fact: Any topological n -manifold, $n \leq 3$, is homeomorphic to a PL manifold, unique up to PL homeomorphism ($n = 2$ Rado:1924)($n = 3$ Moise:1952).]

The set of closed PL n -manifolds is listable (exercise).

So, we can ask: Is the (PL) homeomorphism problem for PL manifolds decidable?

$n \leq 2$: YES. For $n = 2$: $M_1 \cong M_2$ iff $H_1(M_1) \cong H_1(M_2)$ and H_1 (finite complex) is computable.

$n \geq 4$: NO (Markov:1958). Markov's proof uses the fact that for every finitely presented group G , there exists a PL n -manifold ($n \geq 4$) M with $\pi_1(M) \cong G$.

$n = 3$: UNKNOWN.

(1) Harder than $n = 2$ (Lots of 3-manifolds). (2) Easier than $n \geq 4$, e.g. not every finitely presented group G is the fundamental group of a 3-manifold. For example: $\langle a, b : a^{-1}ba = b^2 \rangle$ is not π_1 (3-manifold).

There are many partial results, e.g.

Theorem (Haken; Waldhausen; Jaco-Shalen; Johanson; Hennion: 1979). *There is an algorithm to decide whether or not two given Haken manifolds are homeomorphic.*

“Hence,” there is an algorithm to decide whether or not two knots are equivalent.

In particular:

Theorem (Haken: 1962). *There is an algorithm to decide whether or not a given knot is trivial.*

Theorem (Waldhausen: 1968). *If $G = \pi_1(M)$, M a Haken 3-manifold, then the word problem for G is solvable.*

Theorem (Rubinstein: 1994). *There is an algorithm to decide whether or not a given 3-manifold is homeomorphic to S^3 .*

TIETZE TRANSFORMATIONS:

- (I) $\langle X : R \rangle \mapsto \langle X : R, r \rangle$ where r is a consequence of R , i.e. $r \in N(R) \subset F(X)$
 (II) $\langle X : R \rangle \mapsto \langle X, y : R, y = w(\underline{x}) \rangle$

Theorem (Tietze: 1908). *Two finite presentations present isomorphic groups iff there is a sequence of moves taking one presentation to the other.*

Proof. (\Leftarrow): clear.

(\Rightarrow). Suppose $\langle X : R \rangle, \langle Y : S \rangle$ present the same group G with $X = \{x_1, \dots, x_m\}$, $Y = \{y_1, \dots, y_n\}$. Since X generates G , $y_j = w_j(\underline{x})$, $1 \leq j \leq n$, and since Y generates G , $x_i = v_i(\underline{y})$, $1 \leq i \leq m$.

$$\langle X : R \rangle \mapsto_{II's} \langle X, Y : R, y_j = w_j(\underline{x}) \rangle.$$

The relations S hold in G , and are therefore consequences of these, so:

$$\langle X, Y : R, y_j = w_j(\underline{x}) \rangle \mapsto_{I's} \langle X, Y : R, S, y_j = w_j(\underline{x}) \rangle$$

and since the relations $x_i = v_i(\underline{y})$ hold in G , we have:

$$\langle X, Y : R, S, y_j = w_j(\underline{x}) \rangle \mapsto_{I's} \langle X, Y : R, S, y_j = w_j(\underline{x}), x_i = v_i(\underline{y}) \rangle.$$

Now, by symmetry, there exists a sequence of $I^{-1}s$ and $II^{-1}s$ which yield $\langle Y : S \rangle$. ■

2 Normal Surfaces: The Kneser and Haken Finiteness theorems

I. Normal Surfaces

Let M be a closed connected 3-manifold with a fixed triangulation T . Let $T^{(i)}$ denote the i -skeleton of T , i.e. $T^{(i)} = \cup\{\text{simplices of dimension } \leq i\}$. Let $F \subset M$ be a closed surface (not necessarily connected). By a small ambient isotopy, we may assume F is transverse to each $T^{(i)}$, so $F \cap T^{(0)} = \emptyset$, $F \cap T^{(1)}$ is a finite number of points of transverse intersection, and $F \cap \Delta$, Δ a 2-simplex, is a finite disjoint union of simple closed curves and properly embedded arcs.

Lemma 2.1. *F may be isotoped so that for every 3-simplex $\tau \in T$, each component of $F \cap \partial\tau$ is one of the following 3 types:*

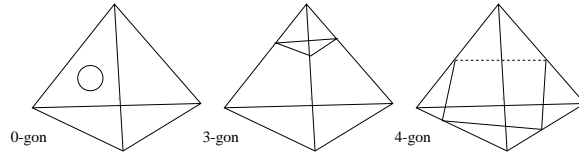

Proof. Define the *weight* of F , $w(F)$ to be $|F \cap T^{(1)}|$, where $|X|$ is the number of components of X . Isotop F to minimize $w(F)$. Let C be a component of $F \cap \partial\tau$, τ some 3-simplex of T . It suffices to prove the following:

CLAIM: C meets each 1-simplex (edge) of τ in at most one point.

Suppose there exists an edge e of τ such that $|C \cap e| > 1$. Now, C bounds a disk in $\partial\tau$, and so there exist two points of $C \cap e$ of opposite sign. Choose such a pair, innermost on e , bounding an arc $\beta \subset e$. Then there exists a disk $D' \subset \partial\tau$ such that $\partial D' = \alpha' \cup \beta$, $\alpha' \subset C$.

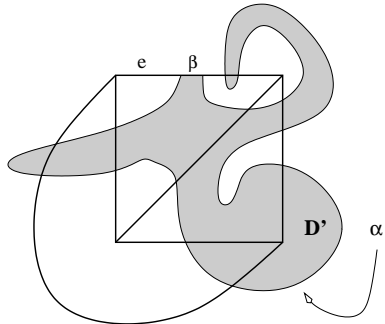

2 NORMAL SURFACES: THE KNESER AND HAKEN FINITENESS THEOREMS6

Let D be a nearby parallel copy of D' ("tilt D' into τ along β "), with $D \subset \tau$, $D \cap \partial\tau = \beta$. $D \cap F = \partial D \cap F = \alpha$, an arc.

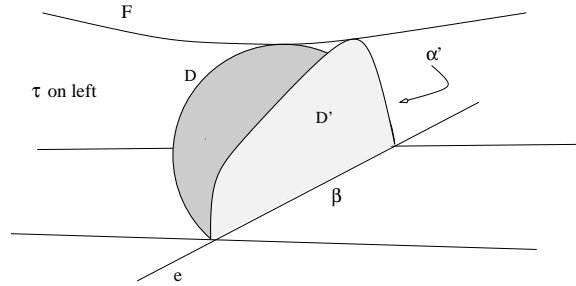

Use D to define an isotopy of F that is fixed outside a small neighborhood of D .

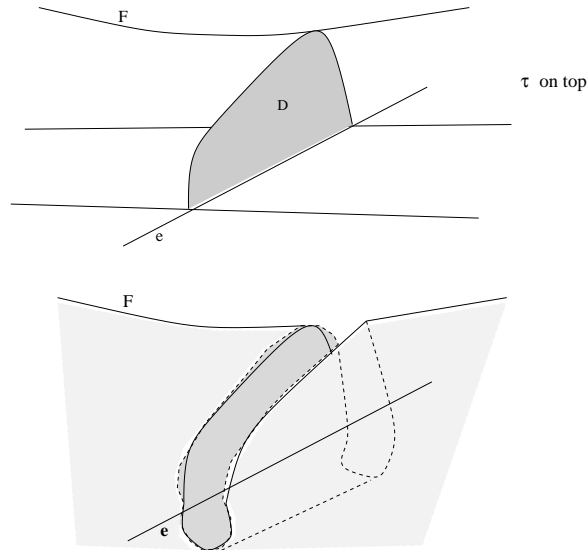

This decreases $w(F)$ by two, contradicting the minimality of $w(F)$. ■

Definition (Kneser: 1929). A surface $F \subset M$ is *normal* (with respect to T) if each component of $F \cap \tau$, for each 3-simplex τ of T , is a disk of one of the following 2 types:

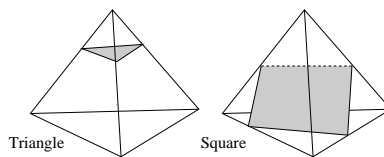

We'll see later that in several interesting cases, we can “make” F normal.

Let $F \subset M$ be a normal surface, τ a 3-simplex of T . Each component of $F \cap \tau$ is one of 7 possible types. There are 4 TRIANGLE types, one for each vertex, and 3 SQUARE types, corresponding to the 3 partitions of the 4 vertices into 2 pairs. Since F is embedded, in fact at most one square type occurs in any given 3-simplex τ .

Definition. Say a component of τ/F (τ cut along F) is *good* if it lies between two components of $F \cap \tau$ of the same type:

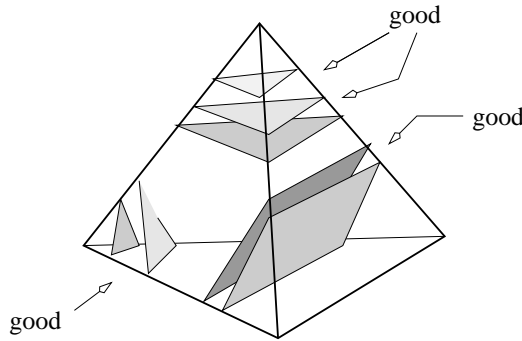

otherwise, *bad*. Say a component X of M/F is *good* if $X \cap \tau$ is good for all 3-simplices τ of T . Otherwise, X is *bad*.

Notice that τ/F has at most 6 bad components. So, the number of bad components of M/F is less than $6t$, where t is the number of 3-simplices in T .

Lemma 2.2. *A good component X of M/F is an I -bundle over a closed surface.*

Let M be a closed $(n-1)$ -manifold. An I -bundle over M is a space X with a map $\rho : X \rightarrow M$ such that for every $x \in M$ there exists a neighborhood U of x in M and a homeomorphism $\rho^{-1}(U) \cong U \times I$ such that the following diagram commutes.

$$\begin{array}{ccc}
 \rho^{-1}(U) & \xrightarrow{\cong} & U \times I \\
 \rho|_{\rho^{-1}(U)} \searrow & & \swarrow \pi \\
 & U &
 \end{array}$$

X is an n -manifold, with $\partial X = (\partial I\text{-bundle over } M)$, $\rho|_{\partial X} : \partial X \rightarrow M$ is a two-fold covering projection, and X is determined by $\rho|_{\partial X} : \partial X \rightarrow M$.

2 NORMAL SURFACES: THE KNESER AND HAKEN FINITENESS THEOREMS

X is the mapping cylinder of $\rho|_{\partial X} : \partial X \rightarrow M$. If $f : A \rightarrow B$, let M_f denote the mapping cylinder of f , i.e.

$$M_f = (A \times I) \sqcup B /_{(a,1) \sim f(a)}$$

for all $a \in A$.

Assume M is connected. Then $|\partial X| = 2$ implies that $X \cong M \times I$, and we say that X is a product I -bundle. If $|\partial X| = 1$, we say X is a twisted I -bundle.

Now, if X is a product I -bundle, then X orientable $\Rightarrow M$ orientable. If X is a twisted I -bundle, then X orientable $\Rightarrow M$ non-orientable.

EXAMPLE: $\mathbb{R}P^n - \text{int}B^n$ is a twisted I bundle over $\mathbb{R}P^{n-1}$.

Lemma 2.3. *Let X be an I -bundle over a closed surface F . Then*

$$H_1(X, \partial X; \mathbb{Z}_2) \cong \mathbb{Z}_2.$$

Proof. Using \mathbb{Z}_2 coefficients, we have, by Lefschetz duality, $H_1(X, \partial X) \cong H^2(X)$, and $H^2(X) \cong H_2(X)$, by the Universal Coefficient Theorem. Since X is an I -bundle over F , we also have $H_2(X) \cong H_2(F) \cong \mathbb{Z}_2$. ■

Lemma 2.4. *Let*

$$0 \rightarrow V_1 \rightarrow V_2 \rightarrow \cdots \rightarrow V_n \rightarrow 0$$

be an exact sequence of finite dimensional vector spaces. Then

$$\sum_{i=1}^n (-1)^i \dim V_i = 0.$$

Proof. Let the homomorphisms be $\varphi_i : V_i \rightarrow V_{i+1}$ ($0 \leq i \leq n$), $V_0 = 0$, $V_{n+1} = 0$, $\varphi_0 = 0$, $\varphi_{n+1} = 0$. The exact sequence determines the short exact sequence

$$0 \rightarrow \ker \varphi_i \rightarrow V_i \cong \text{Im} \varphi_{i-1} \rightarrow \text{Im} \varphi_i \rightarrow 0.$$

So, $\dim V_i = \dim(\text{Im} \varphi_{i-1}) + \dim(\text{Im} \varphi_i)$. Therefore,

$$\sum_{i=1}^n (-1)^i \dim V_i = \dim(\text{Im} \varphi_0) \pm \dim(\text{Im} \varphi_{n+1}) = 0. ■$$

Lemma 2.5. *Let M be a closed 3-manifold, F be a closed surface in M . Let p denote the number of components of M/F that are not twisted I-bundles. Then*

$$p \geq |F| - \dim H_1(M; \mathbb{Z}_2) + 1.$$

Proof. Let the components of F be F_1, F_2, \dots, F_n . Let X_1, X_2, \dots, X_k be the components of M/F that are twisted I-bundles, without loss of generality we assume $\partial X_i = F_i$, $1 \leq i \leq k$. For $k+1 \leq i \leq n$ let X_i be $N(F_i)$, a regular neighborhood of F_i .

Note: $N(F_i)$ is an I-bundle over F_i , $k+1 \leq i \leq n$. Let $X = \bigsqcup_{i=1}^n X_i$. Then $\overline{M - X}$ is the disjoint union of the components of M/F that are not twisted I-bundles. The homology exact sequence of the pair $(M, M - X; \mathbb{Z}_2)$ gives:

$$\dots \rightarrow H_1(M) \rightarrow H_1(M, M - X) \rightarrow H_0(M - X) \rightarrow H_0(M) \rightarrow 0$$

Now, $H_1(M) \cong (\mathbb{Z}_2)^m$. By excision, $H_1(M, M - X) \cong H_1(X, \partial X) \cong (\mathbb{Z}_2)^n$, by Lemma 2.3 with $n = |F|$. Also, $H_0(M) \cong \mathbb{Z}_2$ and $H_0(M - X) \cong (\mathbb{Z}_2)^p$. By Lemma 2.4, $m \geq n - p + 1$, so $p \geq n - m + 1$. ■

Lemma 2.6. *Let M be a closed 3-manifold with a triangulation T , with t the number of 3-simplices. Let F be a normal surface in M . If*

$$|F| \geq 6t + \dim H_1(M; \mathbb{Z}_2) + 1,$$

then some pair of components of F are parallel in M .

Proof. Let $d = \dim H_1(M; \mathbb{Z}_2)$. The number of bad components of M/F is less than or equal to $6t$. The number of components of M/F that are not twisted I-bundles is greater than or equal to $|F| - d$. Therefore, if $|F| \geq 6t + d + 1$, then $6t \leq |F| - d - 1$. Therefore, the number of bad components of M/F is less than or equal to $|F| - d - 1$. Therefore M/F has a good component X that is not a twisted I-bundle. So, $X \cong F_i \times I$. ■

II. Kneser's Prime Decomposition Theorem.

Note: for the following, we are working in the PL category. Let M_i be a closed n -manifold, D_i an n -cell in M_i , for $i \in \mathbb{N}$. Then we define

$$M_i \# M_j = (\overline{M_i - D_i} \cup_h \overline{M_j - D_j})$$

where $h : \partial D_i \rightarrow \partial D_j$ is a homeomorphism.

Two facts:

1. Any two n -cells in a connected n -manifold M are isotopic.
2. Any two orientation preserving homeomorphisms $S^{n-1} \rightarrow S^{n-1}$ are isotopic.

So, $M_i \# M_j$ is well defined up to homeomorphism if M_i , say, is non-orientable, and well defined up to orientation preserving homeomorphism if M_i, M_j are orientable and h is orientation reversing.

Theorem (Kneser). *Let M be a closed 3-manifold. Then*

$$M \cong M_1 \# M_2 \# \dots \# M_n,$$

M_i prime, $1 \leq i \leq n$.

Remark: If M is orientable, then the M_i are unique. Suppose $M = M_1 \# \dots \# M_n$. Then there exist a disjoint union S of $(n-1)$ 2-spheres in M , such that $M/S = \bigsqcup_{i=1}^n M'_i$ where $M'_i \cong M_i - \sqcup \{\text{open 3-cells}\}$. Now, $M_i \cong S^3$ iff $M'_i \cong S^3 - \sqcup \{\text{open 3-cells}\} = \text{punctured } S^3$.

Definition. Say S is a *system of independent 2-spheres* if no component of M/S is a punctured S^3 .

Theorem 2.7. *Let M be a closed 3-manifold. Then there exists $k(M) \in \mathbb{Z}$ such that if S is an independent system of 2-spheres in M , then $|S| \leq k(M)$.*

Note: Theorem 2.7 implies Kneser's Finiteness Theorem.

Definition. Let F be a closed surface in M . Suppose there exists a disk $D \subset M$ such that $D \cap F = \partial D$. Then D has a neighborhood $N(D) \cong D \times I$ such that $N(D) \cap F = \partial D \times I$. Let $F' = (F - (\partial D \times I)) \cup (D \times \partial I)$. So, we say that F' is obtained from F by *surgery along D* .

Lemma 2.8. *Let M be an n -manifold with boundary, $B \cong D^n$, $M' = M \cup_D B$ where $D \cong D^{n-1}$. Then $M' \cong M$.*

Proof. Clear, use the collar on ∂M . ■

Lemma 2.9. *Let S be a 2-sphere in a 3-manifold M . Let $S' \cup S''$ be obtained by surgering S along a disk. If S' and S'' bound 3-cells in M , then so does S .*

Proof. Suppose $S' = \partial B'$, $S'' = \partial B''$, B' , B'' 3-cells.

1. $B' \cap B'' = \emptyset$. Then $S = \partial B$, $B = B' \cup B''$, a 3-cell by Lemma 2.8.
2. $B' \cap B'' \neq \emptyset$. Without loss of generality, we may assume $B' \subset B''$. Let $D' = \overline{S'} - D$. Then $B'' = B \cup_{D'} B'$, where $\partial B = S$. By Lemma 2.8, $B \cong B''$, a 3-cell.

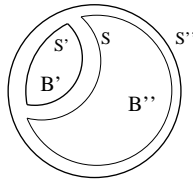

Lemma 2.10. *Let S be a disjoint union of 2-spheres in M . Let D be a disk in M with $D \cap S = \partial D = D \cap S_0$, S_0 a component of S . Let $S' = (S - S_0) \cup S'_0$, $S'' = (S - S_0) \cup S''_0$, where $S'_0 \cup S''_0$ is obtained by surgering S_0 along D . If S is independent then either S' or S'' is independent.*

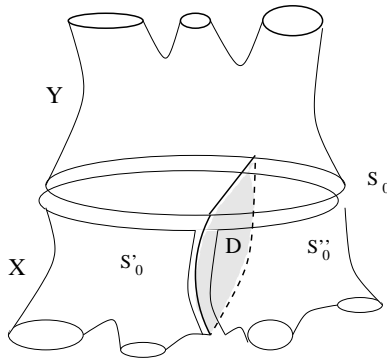

Proof. Let X, Y (possibly $X = Y$) be the components of M/S that meet S_0 . Without loss of generality, let D be a disk in X . Now, $X/D = X' \cup X''$ (possibly $X' = X''$). Suppose S' not independent. Since S is independent, then one of the components of M/S' that meets S'_0 must be a punctured S^3 . Let Z be the disjoint union of $|\partial(X \cup_{S_0} Y)|$ 3-cells. Let $N = (X \cup_{S_0} Y) \cup_{\partial} Z$. So S'_0 bounds a 3-cell in N .

Similarly, if S'' is not independent, the S''_0 bounds a 3-cell in N . So, by Lemma 2.9, S', S'' not independent implies that S_0 bounds a 3-cell in N , and so S is not independent, a contradiction. ■

Alexander's Theorem. *Any (PL) 2-sphere in S^3 bounds a 3-cell in S^3 .*

Note: In the PL category, this is unknown for $S^{n-1} \subset S^n$, $n \geq 4$. The case $n = 4$ implies the result for all $n \geq 4$.

Lemma 2.11. *If M is a closed 3-manifold and contains an independent system of k 2-spheres, then it contains such a system that is normal.*

Proof. Let $S \subset M$ be an independent system of k 2-spheres. Let T be a triangulation of M . Choose S to be in general position with respect to T and such that $w(S)$ is minimal. Then, by Lemma 2.1, each component of $S \cap \partial\tau$, τ a 3-simplex of T , is either a 0-gon, a 3-gon, or a 4-gon.

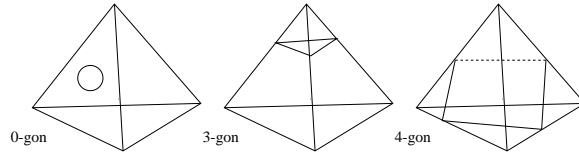

1. We may assume no 0-gons. If $S \cap \partial\tau$ contains a 0-gon, let γ be one that is innermost on the 2-simplex $\Delta \subset \partial\tau$, i.e. there exists a disk $D \subset \Delta$ such that $\gamma = \partial D$, and $\text{int}D \cap S = \emptyset$. Surger S along D and push that resulting S' and S'' slightly off Δ . By Lemma 2.10, S' , say, is independent and the number of 0-gon intersections of S' is less than the number of 0-gon intersections of S .

Note: $w(S'_0) + w(S''_0) = w(S_0)$, S_0 the component of S meeting D , and so $w(S') < w(S)$.

2. For each 3-simplex τ of T , each component of $S \cap \tau$ is a disk. Suppose not. By Alexander's Theorem, no component of S is contained in the interior of τ . Let P be a component of $S \cap \tau$ which is not a disk and is innermost in the sense that some component γ of ∂P bounds a disk $D' \subset \partial\tau$, such that every component of $S \cap \tau$ that meets $\text{int}D'$ is a disk. Then there exists a disk D in the interior of τ such that $D \cap S = \partial D \cap S = \partial D \cap P$ is parallel in P to γ .

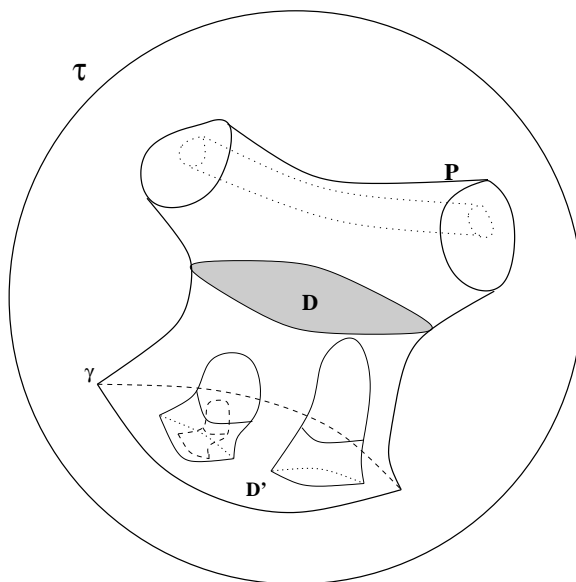

Now, surger S along D to get S' , S'' . So, S' , say, is independent, by Lemma 2.10. So, $w(S') < w(S)$, a contradiction. So, each component of $S \cap \tau$ is a disk.

1. and 2. imply that the system is normal. ■

PROOF OF THEOREM 2.7 Let S be an independent system of 2-spheres in M with $|S| = k$. By Lemma 2.11, we may assume S normal (with respect to some triangulation T of M). S independent implies that no components of S are parallel. Therefore, by Lemma 2.6,

$$k < 6t + \dim H_1(M; \mathbb{Z}_2),$$

t the number of 3-simplices in T .



III. Incompressible surfaces and Haken manifolds

After Kneser's prime decomposition theorem, we may restrict our attention to prime 3-manifolds.

Definition. A 3-manifold M is *irreducible* if every 2-sphere $S \subset M$ bounds a 3-ball $B \subset M$.

Clearly, M irreducible implies M prime. Also,

1. $S^1 \times S^2$ and $S^1 \tilde{\times} S^2$ are prime, but not irreducible.
2. M prime and reducible implies that $M \cong S^1 \times S^2$ or $S^1 \tilde{\times} S^2$.

Definition. Let F be a surface in a 3-manifold M . A *compressing disk* for F in M is a disk $D \subset M$ such that $D \cap F = \partial D \cap F = \partial D$ does not bound a disk in F . If there exists such a disk, F is *compressible*. F is *incompressible* if it is not compressible and no component of F is S^2 .

Assume M is irreducible, F an incompressible surface in M . Suppose D is a disk in M such that $D \cap F = \partial D \cap F = \partial D$. Then F incompressible implies that $\partial D = \partial E$, E a disk in F . $D \cup E = \partial B$, B a 3-ball. Now, we can isotop E across B to D , which gives us a surface F' isotopic to F . Note: $B \cap F = E$. Otherwise, we could isotop F into B , which would contradict the following theorem:

Theorem. *Every closed connected surface $F (\not\cong S^2)$ in S^3 is compressible.*

The proof of the theorem is similar to the proof of Alexander's Theorem. Remark: Let F be a compressible surface in M . Then $\pi_1(F) \rightarrow \pi_1(M)$ is not injective.

Theorem (Disk Theorem ("Dehn's Lemma-Loop Theorem")). *If F is a 2-sided surface in M , then F is compressible if and only if $\pi_1(F) \rightarrow \pi_1(M)$ is not injective.*

Definition. A 3-manifold M is *Haken* if M is irreducible and contains a 2-sided incompressible surface.

Definition. Let M be a 3-manifold. Let $F_1, F_2 \subset M$ be surfaces. Let $D_1 \subset F_1$ be a disk. Then we say that F_1 and F_2 are *disk-equivalent* if there exists a disk $D_2 \subset M$ with $\partial D_2 = \partial D_1$ and $(F_1 - D_1) \cup D_2$ isotopic to F_2 . F_2 is said to be *obtained from F_1 by a disk replacement*.

Lemma. *Let M be a 3-manifold, $F_1, F_2 \subset M$ disk-equivalent surfaces. If F_1 is incompressible, then so is F_2 . Also, if $F \subset M$ is a compressible surface in M , D a compressing disk, and D' disk-equivalent to D , then D is a compressing disk for F .*

Proof. Exercise. ■

Lemma 2.12. *Let M be a closed 3-manifold, and $F \subset M$ an incompressible surface (possibly disconnected), then M contains such a surface that is normal.*

Proof. (cf proof of Lemma 2.11 for spheres) Take F so that $w(F)$ is minimal over all disk-equivalent surfaces and isotop F to be in general position with respect to the triangulation T . By Lemma 2.1, for all 3-simplices τ of T , each component of $F \cap \partial\tau$ is either a 0-gon, 3-gon, or 4-gon.

1. We may assume that $F \cap \partial\tau$ contains no 0-gons: Take an innermost such in some 2-simplex Δ , this bounds a disk $D \subset \Delta$ such that $D \cap F = \partial D$. Since F is incompressible, $\partial D = \partial E$, E a disk in F . Now, $F' = (F - E) \cup D$ is an incompressible surface and can be isotoped to a surface F'' with $w(F'') \leq w(F)$ and the number of 0-gons of intersection of F'' is less than that of F , just push D off of Δ .
2. We can isotop F so that each component of $F \cap \tau$ is a disk. Suppose some component of $F \cap \tau$ is not a disk. *Note:* There are no closed components of $F \cap \tau$, by the theorem above. Let P be a non-disk component of $F \cap \tau$, innermost in the sense of the proof of Lemma 2.11. So, some component γ of ∂P bounds a disk $D' \subset \partial\tau$, and we obtain a disk $D \subset \text{int}\tau$ as before, with $D \cap F = \partial D = D \cap P$ parallel in P to γ . Since F is incompressible, ∂D bounds a disk $E \subset F$. Let $F' = (F - E) \cup D$. Note that $\partial P \neq \partial D'$, for if $\partial P = \partial D'$, then $P = E$, a disk, which contradicts our assumption on P . So, we have two cases: Performing the above disk replacement has
 - (a) eliminated $\partial D'$ from $F \cap T^{(2)}$,
 - (b) eliminated $\partial P - \partial D'$ from $F \cap T^{(2)}$,

and in either case, $w(F') < w(F)$, a contradiction.

■

Theorem 2.13. *Let M be a closed 3-manifold. There exists $h(M) \in \mathbb{N}$ such that if F is an incompressible surface in M with $|F| > h(M)$, then two components of F are parallel.*

Proof. Lemma 2.12 and Lemma 2.6 imply the Theorem.

■

3 Matching Equations, Fundamental Solutions, the Haken Sum

I. Warm Up: Normal 1-Manifolds in Surfaces

Let F be a closed surface, T a triangulation of F . Let C be a 1-manifold in F . C is normal (with respect to T) if every component of $C \cap \Delta$, Δ a 2-simplex of T , is a normal arc:

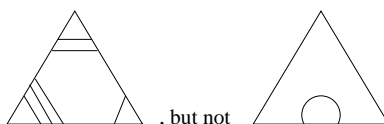

C is essential if no component of C bounds a disk in F .

Theorem 3.1. *Let C be an essential 1-manifold in a surface F . If we isotop C to minimize $w(C)$, then C is normal.*

Proof. Exercise. ■

Let t be the number of 2-simplices in T , C a normal 1-manifold in F . Then C determines a $3t$ -tuple of non-negative integers. There are three arc types in each 2-simplex Δ , one for each vertex. Let x_1, x_2, x_3 denote the number of arcs of each type in Δ_1 , x_4, x_5, x_6 denote the number of arcs of each type in Δ_2 , et cetera.

Then the x_i satisfy $\frac{3t}{2}$ matching equations, one for each 1-simplex of T , of the form

$$x_p + x_q = x_r + x_s.$$

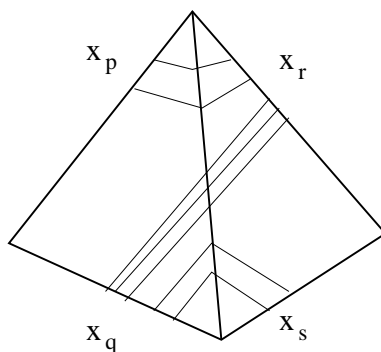

Clearly, the set of normal 1-manifolds in F is in one to one correspondence with the set of solutions in \mathbb{Z}_+^{3t} of the matching equations.

Remark: A *singular triangulation* of a closed n -manifold M ($n = 2, 3$), is a decomposition of M as a union of n -simplices, where the $(n - 1)$ faces are identified in pairs. So, the n -simplices are not necessarily embedded in M . This allows us to get away with fewer n -simplices. The whole theory of normal surfaces, normal 1-manifolds, goes through for singular triangulations. *Example: Essential simple closed curves in a Klein Bottle*

Here is a singular triangulation of F with two 2-simplices, three 1-simplices, and one 0-simplex:

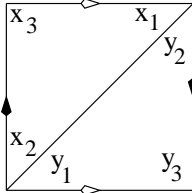

The matching equations are:

$$\begin{aligned} x_1 + x_2 &= y_1 + y_2 \\ x_2 + x_3 &= y_2 + y_3 \\ x_3 + x_1 &= y_3 + y_1 \end{aligned}$$

The general solution is given by:

$$\begin{aligned} x_1 &= y_1 = a \\ x_2 &= y_2 = b \\ x_3 &= y_3 = c \end{aligned}$$

Let $C(a, b, c)$ be the normal 1-manifold corresponding to the 6-tuple $(a, b, c, a, b, c) \in \mathbb{Z}_+^6$. Let C be an essential simple closed curve in F . Then C is isotopic to $C(a, b, c)$ by Theorem 3.1. Now,

1. At least one of a, b, c is zero. For if not, C is *vertex linking*, which implies that C is inessential, a contradiction.

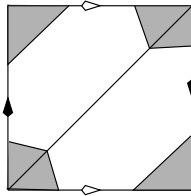

3 MATCHING EQUATIONS, FUNDAMENTAL SOLUTIONS, THE HAKEN SUM 19

2. If $a = 0$, then $b = 0$ or $c = 0$, for if not, C is not connected.

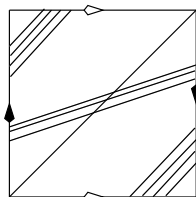

3. If $a = b = 0$, then $c = 1$ or 2 . Otherwise, C is not connected.

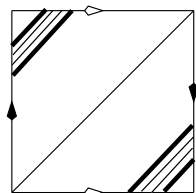

4. If $a = c = 0$, then $b = 1$ or 2 . Otherwise C is not connected.

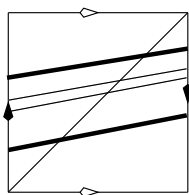

By (2),(3),(4), we may assume $a \neq 0$.

5. If $a \neq 0$, then $c = 0$. If not, then $b = 0$ by (1).

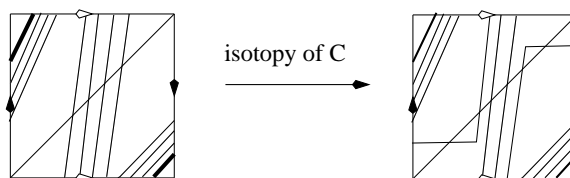

Now isotop to decrease weight.

6. If $a \neq 0$, then $a = 1$, and $b = 0$ or 1 . Assume $a \neq 0$. If $b = 0$, then

3 MATCHING EQUATIONS, FUNDAMENTAL SOLUTIONS, THE HAKEN SUM20

$a = 1$, since C is connected.

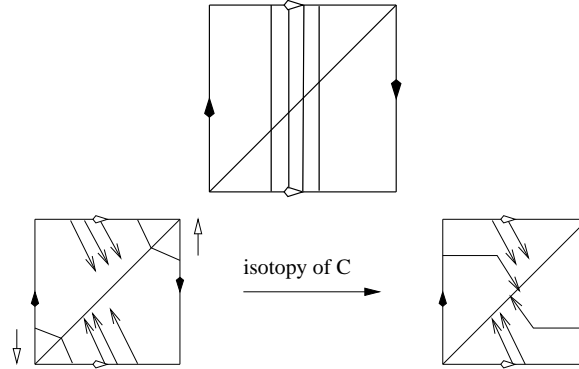

Suppose $b > 0$, $a > 1$.

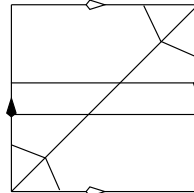

If $a = 1$, $b > 0$, then $b = 1$ by connectivity.

Summarizing: any essential simple closed curve C is isotopic to one of

$$C(0, 0, 1), C(0, 0, 2), C(0, 1, 0),$$

$$C(0, 2, 0), C(1, 0, 0), C(1, 1, 0).$$

Now, $C(0, 0, 1)$ and $C(1, 1, 0)$ are isotopic:

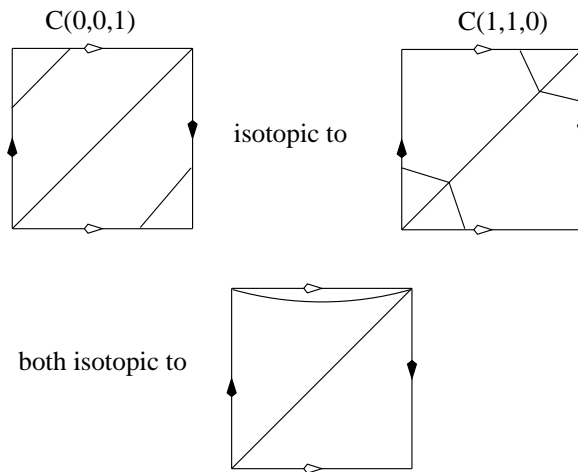

3 MATCHING EQUATIONS, FUNDAMENTAL SOLUTIONS, THE HAKEN SUM21

and $C(0, 0, 2)$ and $C(0, 2, 0)$ are isotopic:

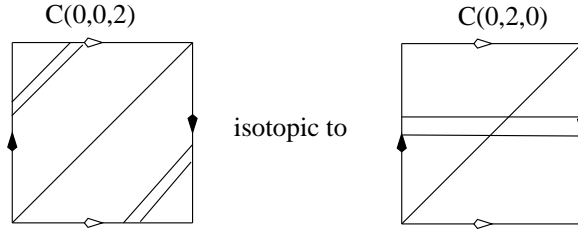

So, we have $\alpha_1 = C(0, 0, 1)$, $\alpha_2 = C(0, 2, 0)$, which are both orientation reversing and distinct in \mathbb{Z}_2 homology. And also $\beta = C(0, 2, 0)$, orientation preserving and separating; and $\gamma = C(1, 0, 0)$, orientation preserving and non-separating. In particular, β separates F into two Möbius bands B_1, B_2 , with α_i the core of B_i :

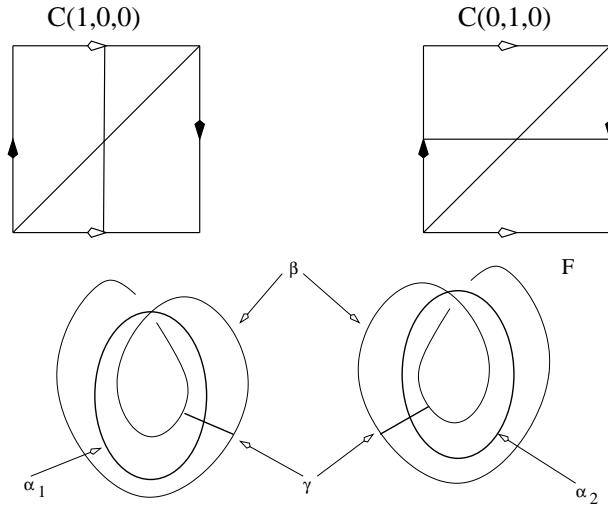

So, there are 4 isotopy classes of essential simple closed curves on a Klein bottle.



Let M be a closed 3-manifold, T a triangulation with t 3-simplices, F a normal surface in M . The components of $F \cap \tau$, τ any 3-simplex of T , are disks of one of seven types: four Triangle types, three Square types. So F determines a $7t$ -tuple $(x_1, \dots, x_8, \dots) \in \mathbb{Z}_+^{7t}$. F embedded implies the Square Condition: for each τ , at most one Square type has nonzero coordinate.

3 MATCHING EQUATIONS, FUNDAMENTAL SOLUTIONS, THE HAKEN SUM22

Let Δ be a 2-simplex of T ; $F \cap \Delta$ is a set of normal arcs in Δ . Let τ, τ' be the two 3-simplices containing Δ . Each arc type in Δ corresponds to one of two disk types in τ (τ') (one Triangle type, one Square type). So, for each 2-simplex Δ we get 3 matching equations of form:

$$\underbrace{x_p + x_q}_{\tau} = \underbrace{x_r + x_s}_{\tau'}$$

and since we have a total of $\frac{4t}{2}$ 2-simplices, we get $6t$ matching equations. Clearly the set of normal surfaces in M is in one to one correspondence with the set of solutions of the matching equations in \mathbb{Z}_+^{7t} satisfying the Square Condition.

Consider a finite system of homogeneous equations in n unknowns.

$$(*) \quad Ax = 0$$

where the entries of A are in \mathbb{Z} . We seek solutions of $(*)$ in \mathbb{Z}_+^n .

Theorem 3.2. *There exists a finite set $\mathfrak{S} \subset \mathbb{Z}_+^n$ of solutions of $(*)$ such that every solution of $(*)$ is a sum of solutions in \mathfrak{S} . Moreover, \mathfrak{S} is constructible, i.e. there exists an algorithm which, given A , produces \mathfrak{S} . \mathfrak{S} is called a fundamental set of solutions.*

Let $V = \{\text{solutions of } (*) \text{ in } \mathbb{R}^n\}$, a subspace of \mathbb{R}^n . Let $\Delta = \Delta^{n-1}$ be the standard $(n-1)$ -simplex in \mathbb{R}^n , i.e.

$$\Delta = \{(x_1, \dots, x_n) : x_i \geq 0, \sum_{i=1}^n x_i = 1\}$$

$$= cx\{(1, 0, \dots, 0), (0, 1, 0, \dots, 0), \dots, (0, \dots, 0, 1)\}$$

where for $X \subset \mathbb{R}^n$, $cx(X) = \{tx + (1-t)x' : x, x' \in X, 0 \leq t \leq 1\}$.

Note that every face of Δ is a standard $(m-1)$ -simplex in some m -dimensional coordinate subspace $\mathbb{R}^m \subset \mathbb{R}^n$. We're interested in $V \cap \Delta = C$.

Lemma. *Let $\sigma_1, \dots, \sigma_k$ be the faces of Δ such that $V \cap \overset{\circ}{\sigma}_i$ is a single point $v^{(i)}$. Then,*

1. $C = cx\{v^{(1)}, \dots, v^{(k)}\}$,
2. $v^{(i)} \in \mathbb{Q}^n$, where $v^{(i)}$ are the vertices of C .

3 MATCHING EQUATIONS, FUNDAMENTAL SOLUTIONS, THE HAKEN SUM23

Proof. 1. We proceed by induction on n . Let P be the affine $(n-1)$ -subspace of \mathbb{R}^n containing Δ . If $V \cap \overset{\circ}{\Delta} = \emptyset$, i.e. $V \cap \Delta = V \cap \partial\Delta$, then the result holds by induction. (Note that $V \cap \partial\Delta \subset V \cap F$, F some $(n-2)$ -dimensional face of Δ .) Also, if $V \cap \overset{\circ}{\Delta}$ is a single point, we're done. Otherwise, let $x \in V \cap \overset{\circ}{\Delta}$. Then $x \in L$, L an affine line in $V \cap P$. Therefore,

$$\begin{aligned} x \in cx(V \cap \partial\Delta) &=_{\text{by induction}} cx\left(\bigcup_F cx\{v^{(i)} : v^{(i)} \in F\}\right) \\ &= cx\{v^{(1)}, \dots, v^{(k)}\} \end{aligned}$$

where F ranges over all $(n-2)$ -dimensional faces of Δ . Therefore, $C = cx\{v^{(1)}, \dots, v^{(k)}\}$.

2. Now, $v^{(j)}$ is the unique solution of a linear system of the form

$$\underbrace{Ax = 0}_V$$

with

$$\underbrace{x_{i_1} = x_{i_2} = \dots = x_{i_{n-m}} = 0 \text{ and } \sum x_i = 1}_{\text{defines } \sigma_j}$$

with all coefficients in \mathbb{Z} . So, $v^{(j)} \in \mathbb{Q}$. ■

Proof of Theorem 3.2. For all $v^{(i)}$, let d_i be the lcm of the denominators of the $v_j^{(i)}$ such that $1 \leq j \leq n$, and let $w^{(i)} = d_i v^{(i)} \in \mathbb{Z}^n$. For $x \in \mathbb{R}_+^n$, define $|x| = \sum_{j=1}^n x_j$. Suppose $z \in \mathbb{Z}_+^n$ is a solution of (*). Then $|z| \in \mathbb{Z}_+ - \{0\}$, and $\frac{z}{|z|} \in C$. Therefore, by the first part of the Lemma,

$$\frac{z}{|z|} = \sum_{i=1}^k \lambda_i v^{(i)} \quad (\lambda_i \geq 0, \sum \lambda_i = 1)$$

Therefore, $z = \sum_{i=1}^k \mu_i w^{(i)}$. Suppose $|z| > \sum_{i=1}^k |w^{(i)}|$. Then, $\mu_j > 1$ for some j , $1 \leq j \leq k$. Let $z' = z - w^{(j)}$. Then $z' \in \mathbb{Z}_+^n$, is a solution of (*), and $|z'| < |z|$. So, we can take

$$\mathfrak{S} = \{w^{(1)}, \dots, w^{(k)}\} \cup \{\text{solutions } z \in \mathbb{Z}_+^n \text{ of } (*) \text{ with } |z| \leq \sum |w^{(i)}|\}$$

Clearly, \mathfrak{S} is constructible.



Let M be a closed 3-manifold with triangulation T . Let F_1, F_2 be normal surfaces in M . By an arbitrarily small normal isotopy, we can ensure that

1. $(F_1 \cap F_2) \cap T^{(1)} = \emptyset$
2. Let α_i be an arc of $F_i \cap \Delta$, Δ some 2-simplex of T , $i = 1, 2$, then $|\alpha_1 \cap \alpha_2| \leq 1$.
3. Let D_i be a component of $F_i \cap \tau$, τ a 3-simplex of T , $i = 1, 2$, then $D_1 \cap D_2 = \emptyset$ or a single arc.

Now, $F_1 \cap F_2$ is a disjoint union of simple closed curves. We say that F_1 and F_2 are *compatible* if, in each 3-simplex τ , $(F_1 \cap \tau) \cup (F_2 \cap \tau)$ contains at most one Square type. If F_1 and F_2 are compatible normal surfaces, with $F_1 \cap F_2$ as above, then we can form the *Haken Sum* $F_1 + F_2$ as follows: F is obtained by *cutting and pasting* F_1 and F_2 along simple closed curves $F_1 \cap F_2$, by making *regular switches*, i.e. for each 2-simplex Δ , we preserve normality on $F_1 \cap F_2$. Using the compatibility condition, we can now extend this cutting and pasting along the arcs of intersection of the normal disks of $F_1 \cap \tau$ and those of $F_2 \cap \tau$ for all 3-simplices τ . We shall see below that F is a normal surface.

Note: The compatibility condition is needed, as the following figure demonstrates. The regular switch instructions at the two ends of $D_1 \cap D_2$ are incompatible:

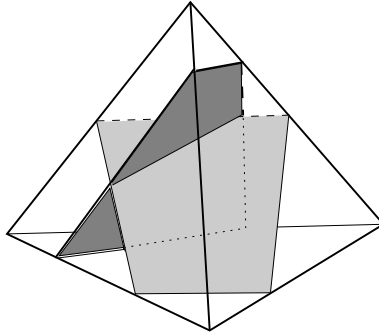

Let the vectors in \mathbb{Z}_+^n corresponding to F_1, F_2 and F be $x^{(1)}, x^{(2)}, x$. Then

$$x = x^{(1)} + x^{(2)}$$

Since F is obtained by “disassembling and reassembling” F_1 and F_2 , we have that

$$(\# \text{ } i\text{-simplices in } F_1) + (\# \text{ } i\text{-simplices in } F_2) = (\# \text{ } i\text{-simplices in } F)$$

with respect to any triangulation of F_1 and F_2 . So, we have

$$\chi(F) = \chi(F_1) + \chi(F_2)$$

Also, it is clear that

$$w(F) = w(F_1) + w(F_2)$$

The Haken Sum is also associative:

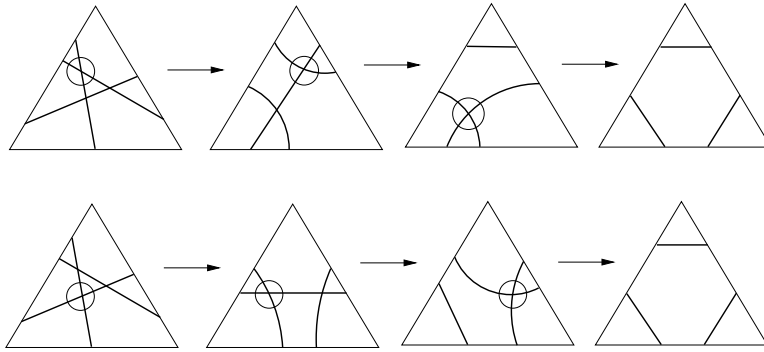

Let $x \in \mathbb{Z}_+^n$ be a fundamental solution of the matching equations that satisfies the Square Condition. Then x yields a normal surface F , which we call a *fundamental surface*.

Theorem 3.3. *Every normal surface can be expressed as a sum of fundamental ones.*

Proof. Let F be a normal surface. F yields a solution $x \in \mathbb{Z}_+^n$ of the matching equations. Therefore $x = \sum_{i=1}^m x^{(i)}$, $x^{(i)} \in \mathfrak{S}$. Since x satisfies the Square Condition, each $x^{(i)}$ does. Therefore, each $x^{(i)}$ yields a normal surface $F^{(i)}$ and $F^{(1)}, \dots, F^{(m)}$ are compatible. So, $F' = F^{(1)} + \dots + F^{(m)}$ is defined. But, the solution of the matching equations corresponding to F' is exactly x . So, $F' = F$. ■

Definition. Let M be a closed 3-manifold with triangulation T . $F_0 \subset M$ is an *immersed normal surface* if

3 MATCHING EQUATIONS, FUNDAMENTAL SOLUTIONS, THE HAKEN SUM26

1. $F_0 \cap T^{(0)} = \emptyset$.
2. For each 2-simplex Δ of T , $F_0 \cap \Delta$ is a union of normal arcs, each pair intersecting transversely in at most one point.
3. For each 3-simplex τ of T , $F_0 \cap \tau$ is a union of normal disks with
 - (a) All squares are of the same type
 - (b) For each pair of normal disk D, D' ,

$$D \cap D' = \begin{cases} \emptyset \text{ or one arc} & \text{if } D \text{ or } D' \text{ is a triangle} \\ \emptyset \text{ or one or two arcs} & \text{if } D \text{ and } D' \text{ are squares} \end{cases}$$

- (c) $D \cap D' \cap D'' = \emptyset$ for any triple of normal disks.

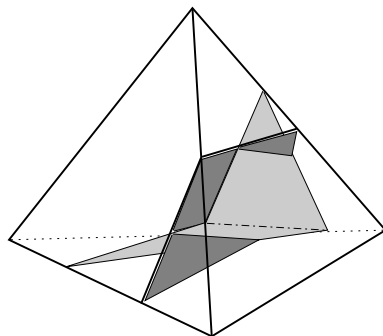

Note: The *singular set* Γ of F_0 is a disjoint union of simple closed curves, all double curves, i.e. there are no triple points.

Now, given an immersed normal surface, we may not be able to perform regular switches along Γ in order to obtain a normal surface. The following example, suggested by Saul Schleimer, demonstrates the difficulty:

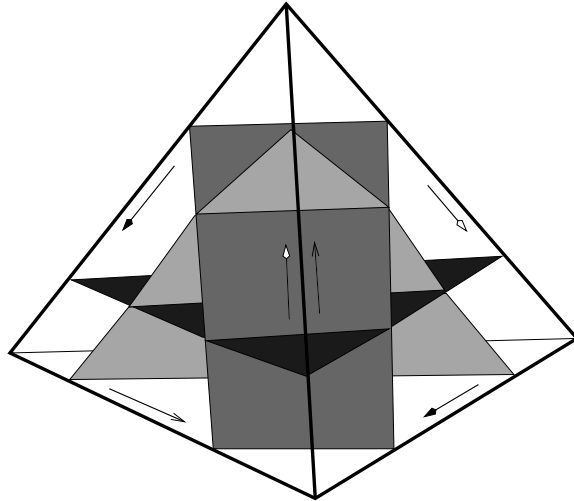

The two faces of the tetrahedron facing the reader are identified by a $\frac{1}{3}$ twist, the square and the two triangles becoming an immersed normal surface with one curve of self intersection. Now, in an attempt to perform a regular switch, we begin by following the regular switch instructions at one intersection point in the face of the tetrahedron. Continuing along the curve, we obtain the following abnormal surface:

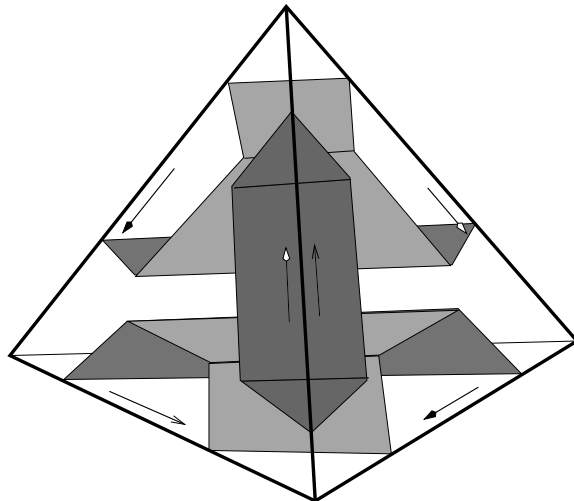

To elucidate the problem, consider the intersection of the surface with the identified face:

3 MATCHING EQUATIONS, FUNDAMENTAL SOLUTIONS, THE HAKEN SUM28

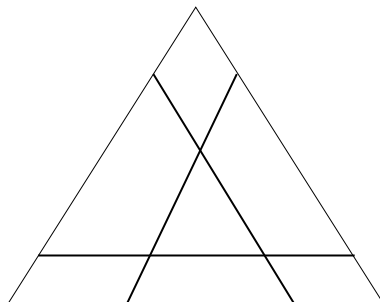

Now, after each switch is performed we label the intersection in our original picture with r 's and i 's, which serves as our regular switch instructions, like so:

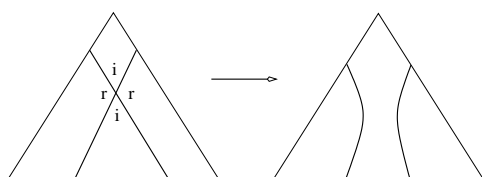

Beginning at the North intersection and performing regular switches in a clockwise fashion, we have the following set of instructions:

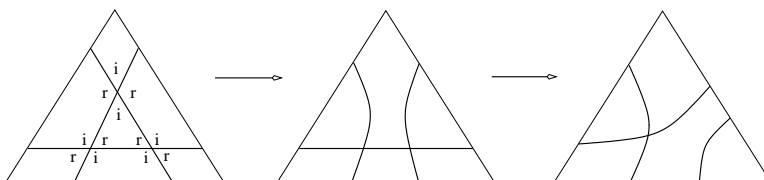

Beginning at the Southwest intersection and performing regular switches in a clockwise fashion, we have the following set of instructions:

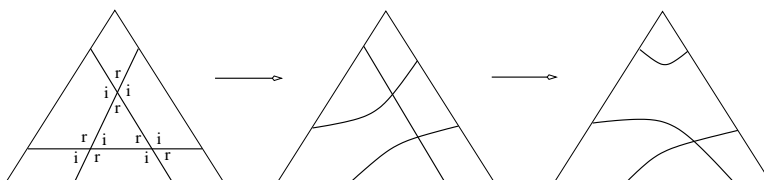

Luckily, if the immersed surface is the union of two embedded ones, then this does not happen, thanks to the two following lemmas.

3 MATCHING EQUATIONS, FUNDAMENTAL SOLUTIONS, THE HAKEN SUM29

Lemma. *Let $\alpha = \bigcup_{i=1}^m \alpha_i$, $\beta = \bigcup_{j=1}^n \beta_j$ be properly embedded normal 1-manifolds in a 2-simplex, all α_i, β_j arcs, such that $|\alpha_i \cap \beta_j| \leq 1$ and $|\alpha_p \cap \beta_q| = 1$ for some p, q . Then there exists a pair of arcs α' and β' that cobound an outermost triangle with one side lying in one edge of the 2-simplex:*

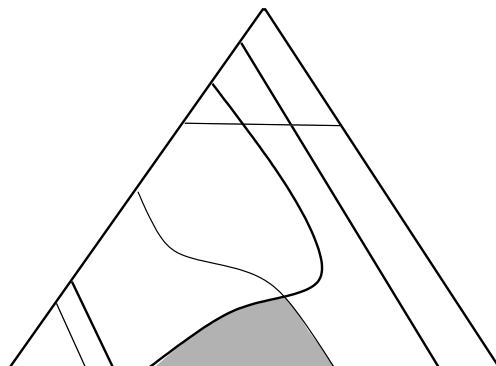

Proof. We induct on the number of arcs, $m + n$. If α and β each consist of a single arc, then we have the following picture and we are done:

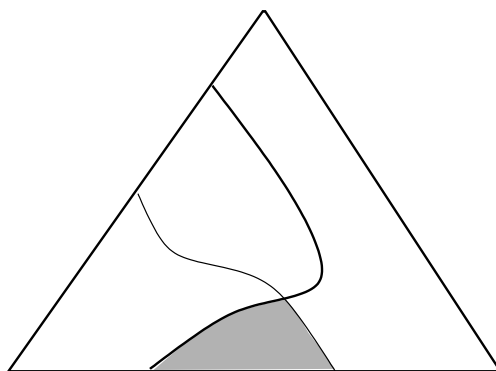

Now, suppose the result is true for all such 1-manifolds with $m + n \leq k$. Now, let α and β be such 1-manifolds with $k + 1$ arcs total. Now, $B = (\alpha \cup \beta) - \beta_l$ is a 1-manifold with k arcs and by the inductive hypothesis, we have two arcs α' and β' in B which cobound a triangle. Now, if β_l does not intersect this triangle, then we're done. If β_l does intersect this triangle, the α' and β_l are the desired arcs:

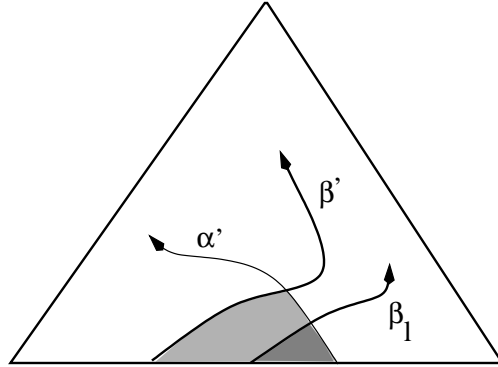

■

Lemma. Let $\alpha = \bigcup_{i=1}^m \alpha_i$, $\beta = \bigcup_{j=1}^n \beta_j$ be properly embedded normal 1-manifolds in a 2-simplex such that α_i, β_j are all arcs with the property that $|\alpha_i \cap \beta_j| \leq 1$. Then the regular switch instructions are independent of the order in which regular switches are performed along $\alpha \cap \beta$.

Proof. We proceed by induction on $|\alpha \cap \beta|$. If $|\alpha \cap \beta| = 0$, then there is nothing to show. Now, suppose the result holds for all such 1-manifolds with $|\alpha \cap \beta| \leq k$. Now let α and β be such manifolds with $|\alpha \cap \beta| = k + 1$. Now, by the previous lemma, there are two arcs α_p and β_q which cobound a triangle with an edge in one face of the 2-simplex. Now, there is only one possible choice for a regular switch at the point $\alpha_p \cap \beta_q$. Let α'_p and β'_q be the traces of α_p and β_q after performing the regular switch at $\alpha_p \cap \beta_q$, as pictured:

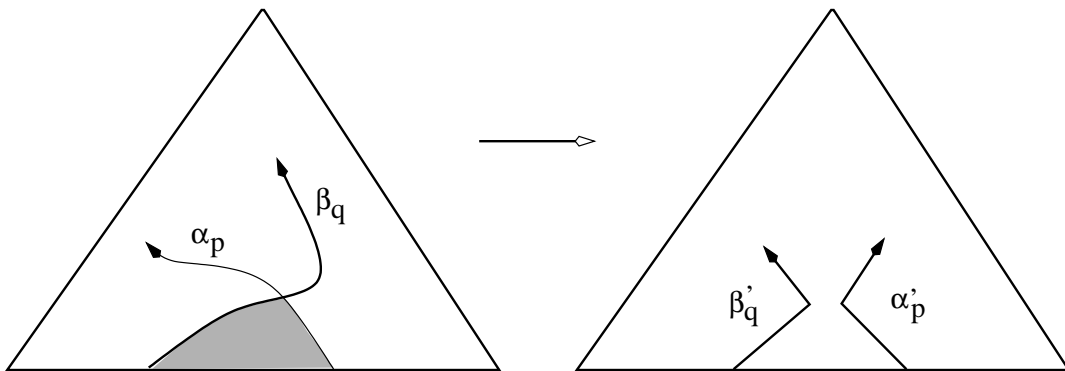

Note that α'_p, β'_q only intersect arcs of β and α respectively. Now, replacing α_p by α'_p and β_q by β'_q in α and β respectively, we obtain two embedded 1-manifolds α' and β' with $|\alpha' \cap \beta'| = k$, and so by induction, the regular switch instructions at this stage are independent of order. But this means that the instructions are independent for $\alpha \cup \beta$, as there is no choice involved at the point $\alpha_p \cap \beta_q$. ■

In particular, given embedded normal surfaces F_1 and F_2 , we can isotop F_1 , say, through normal surfaces so that $F_1 \cup F_2$ is an immersed normal surface. Then we may perform regular switches along Γ **in any order** to obtain a normal surface F . From now on, we concern ourselves only with immersed surfaces which are “descendants” of embedded ones:

Definition. Let F_1, F_2 be compatible embedded normal surfaces in a 3-manifold M . Let F be the immersed surface obtained from $F_1 \cup F_2$ by performing regular switches on some subcollection of curves in $F_1 \cap F_2$. Then we say that that F is an *immersed surface of embedded descent*.

Lemma 3.4. *Let F be a connected normal surface that is not fundamental, i.e. $F = G + H$, ($G, H \neq \emptyset$), with $|G \cap H|$ minimal. Then,*

1. G and H are connected
2. no component γ of $G \cap H$ separates both G and H .

Proof. 1. Suppose $H = H_1 \sqcup H_2$ ($H_1, H_2 \neq \emptyset$). Let $G' = G + H_2$. Since F is connected, $G \cap H_2 \neq \emptyset$. Then $F = G' + H_1$ and $|G' \cap H_1| < |G \cap H|$, a contradiction.

3 MATCHING EQUATIONS, FUNDAMENTAL SOLUTIONS, THE HAKEN SUM 32

2. Suppose γ , a component of $G \cap H$, separates G and H :

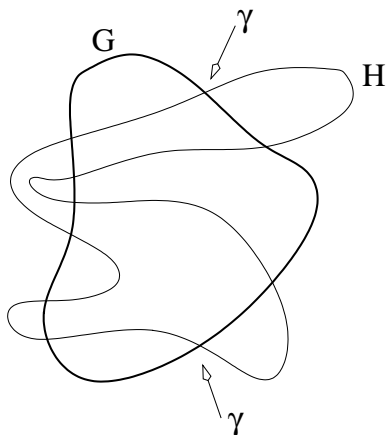

Performing a regular switch along γ , we obtain two immersed normal surfaces F_1 and F_2 of embedded descent:

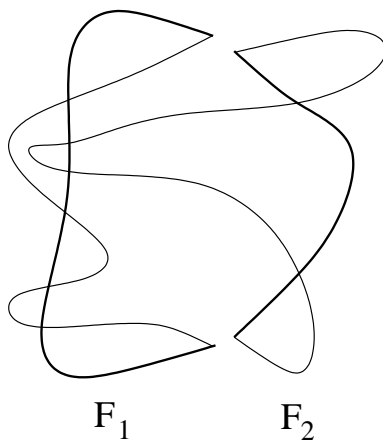

Note: γ separates G into G_1 and G_2 , H into H_1 and H_2 . Without loss of generality,

$$F_1 = G_1 \cup H_1$$

$$F_2 = G_2 \cup H_2$$

Doing regular switches along the self intersections of F_1 and F_2 , we obtain two embedded normal surfaces F'_1 , F'_2 with $F = F'_1 + F'_2$ and $|F'_1 \cap F'_2| < |G \cap H|$, a contradiction.

■

If γ is a double curve of an immersed normal surface, we can do an *irregular switch* along γ :

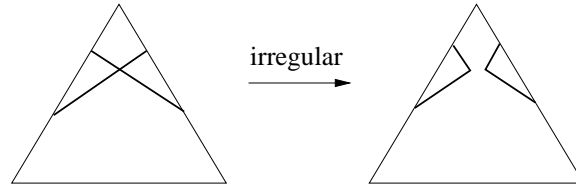

Lemma 3.5. *Let H be an immersed normal surface of embedded descent with singular set Γ . Let F be the normal surface obtained from H by doing regular switches along Γ , and let G be the (embedded) surface obtained from H by doing irregular switches along Γ . Then G is isotopic to G' with $w(G') < w(F)$.*

Proof. There is some 2-simplex Δ of T such that $G \cap \Delta$ is not normal, i.e. there exists an arc component with both endpoints lying in the same edge of Δ , and we can isotop G to reduce $w(G)$.

■

Remark. If $F \subset M$ is compressible, with compressing disk D , then ∂D is 2-sided in F . Hence, if $P \subset M$ is a projective plane, then P is incompressible.

Definition. Let F_0 be an immersed normal surface in M with singular set Γ . A *region* of F_0 is a component of F_0/Γ .

For example, if $F_0 = F_1 \cup F_2$, F_1, F_2 normal surfaces, then a region is a component of $(F_1 \cup F_2)/(F_1 \cap F_2)$.

From now on, we shall assume that M is orientable. So, if F_1, F_2 are surfaces in M , γ a component of $F_1 \cap F_2$, then γ is 2-sided in F_1 iff γ is 2-sided in F_2 .

4 Finding Geometrically Essential 2-Spheres

Let M be a 3-manifold. A 2-sphere $S \subset M$ is *geometrically essential* if S does not bound a 3-cell in M .

Remarks. Let S be a 2-sphere in M . S is *essential* if $[S] \neq 0 \in \pi_2(M)$. Clearly S essential implies S geometrically essential. S non-separating implies S essential. S separating ($M = M'_1 \cup_S M'_2$), i.e. $M = M_1 \# M_2$ ($M_i = M'_i \cup B^3$), then S essential if and only if $\pi_1(M_i) \neq 1$, $i = 1, 2$. (Hence, modulo the Poincaré Conjecture, S essential is equivalent to S geometrically essential.)

Theorem (Papakyriakopoulos). $\pi_2(M) \neq 0$ implies that there exists an embedded essential 2-sphere $S \subset M$.

Lemma 4.1. *Let M be a closed 3-manifold. If M contains a geometrically essential S^2 or P^2 then it contains a fundamental surface which is either a geometrically essential S^2 or a P^2 .*

Proof. Let T be a triangulation of M . If M contains a geometrically essential S^2 , then, by Lemma 2.11, it contains a normal one, say S , of least weight among all spheres in M . If M contains a P^2 , then, by Lemma 2.12, it contains a normal one of least weight among all projective planes in M . Let F be a normal surface, either a geometrically essential 2-sphere or a projective plane, of least weight among all geometrically essential 2-spheres and projective planes in M .

CLAIM: F is a fundamental surface.

Proof of Claim. Suppose F not fundamental. Then $F = G + H$ ($G, H \neq \emptyset$). Choose such G, H with $|G \cap H|$ minimal. Let Γ denote $G \cap H$. Now, $0 < \chi(F) = \chi(G) + \chi(H)$. Therefore, without loss of generality, $\chi(G) > 0$. Therefore G is S^2 or P^2 . Now, $w(F) = w(G) + w(H)$, with $w(G), w(H) > 0$. So, $w(G) < w(F)$. Now, by the minimality of $w(F)$, the only possibility for G is a geometrically inessential 2-sphere, i.e. $G \cong S^2$ and $G = \partial B^3$.

Case I, $F \cong S^2$ Recall that a *region* is a component of $(G \cup H)/\Gamma$. Let D be a disk region in G , $\partial D = \gamma$ (see Figure 1). So, γ is 2-sided in G and H , as M is orientable. Now D yields a disk, call it D again, in F , and γ yields two curves γ' and γ'' in F with $\gamma' = \partial D$ (see Figure 2).

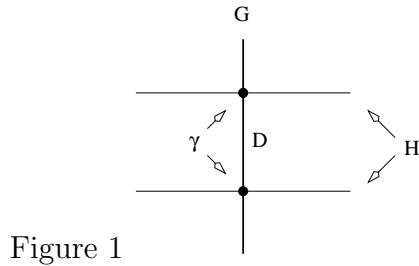

Figure 1

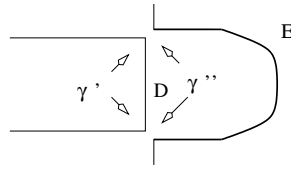

Figure 2

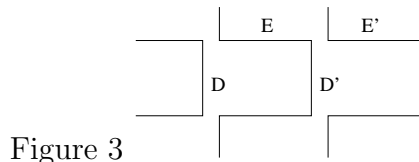

Figure 3

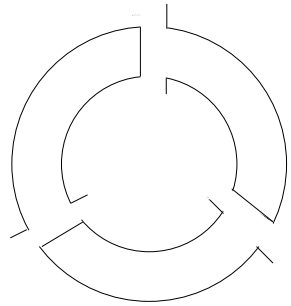

Figure 4

Now, γ'' separates F into 2 disks. Let E be the one shown in Figure 2. If E is a region of $G \cup H$, then γ separates both G and H . This contradicts Lemma 3.4. Therefore, there exists a region $D' \subset \text{int}E$ ($D' \subset G$). Let this be the disk shown in Figure 3. As above, we have a γ' that separates E into an annulus and a disk, say E' . Again, E' cannot be a region, so there exists a disk region $D'' \subset E'$; et cetera. Continue in this fashion until you first get an E that contains a previous D , i.e. we get a cycle: $D_0, E_0, D_1, E_1, \dots, D_{k-1}, E_{k-1}$, where D_i is a disk region; $\partial D_i = \gamma_i$ ($D_i \subset G$) (see Figures 4,5). E_i is a disk in F with $\partial E_i = \gamma''_i$, $D_{i+1} \subset \text{int}E_i$, all indices modulo k .

$k > 1$ Let S_i be the 2-sphere $D_i \cup E_i$. Let F_i be the immersed normal surface obtained from $G \cup H$ by doing regular switches along all components of Γ except γ_i (see Figure 6). Now, a regular switch along γ_i yields F and an irregular switch along γ_i yields a surface with S_i as a component (see Figure 7). Therefore, by Lemma 3.5, S_i is isotopic to S'_i with $w(S'_i) < w(F)$. Therefore, by assumption on F , S_i bounds a 3-cell B_i in M . So, B_i is as shown in Figure 7. Otherwise $F \subset B_i$, contradicting non-triviality of F . We can use these B_i , $i \in \mathbb{Z}/n\mathbb{Z}$, to define an isotopy of F , to F' , see Figure

8. Doing regular switches on $G \cup H$ along all components of Γ except $\gamma_0, \gamma_1, \dots, \gamma_{k-1}$, we get $F' \cup F''$, F' , F'' normal surfaces, $F'' \neq \emptyset$, F' isotopic to F , and $F = F' + F''$ (see Figure 8). So, $w(F) = w(F') + w(F'')$ and so $w(F') < w(F)$, a contradiction.

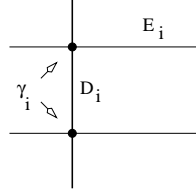

Figure 5

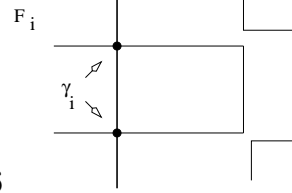

Figure 6

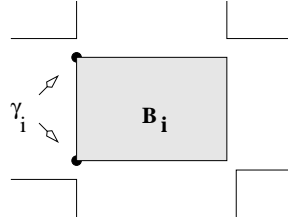

Figure 7

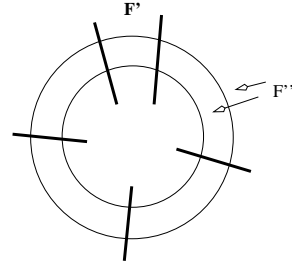

Figure 8

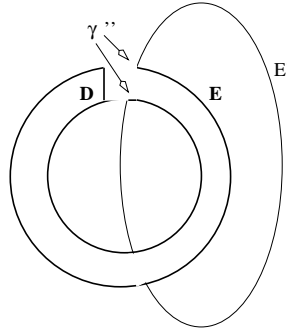

Figure 9(a)

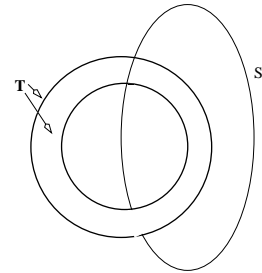

Figure 9(b)

$k = 1$ $D \subset \text{int}E$. $F = E \cup E'$, E' a disk (Figure 9a). Let $S = D \cup E'$. S is a nonseparating 2-sphere in M , and therefore geometrically essential. As above, we get $F = S + T$ (see Figure 9b.). Therefore $w(S) < w(F)$, a contradiction.

Case II, $F \cong P^2$ As in case I, let D be a disk region in G . $\partial D = \gamma$, γ is two-sided in G , and so is two-sided in H , as M is orientable. So, we have γ'' two-sided in $F \cong P^2$, and so γ'' bounds a disk $E \subset F$. If E is

as shown in Figure 10, proceed as in case I.

Suppose $F/\gamma'' = E \cup B$, B a Möbius band (Figure 11).

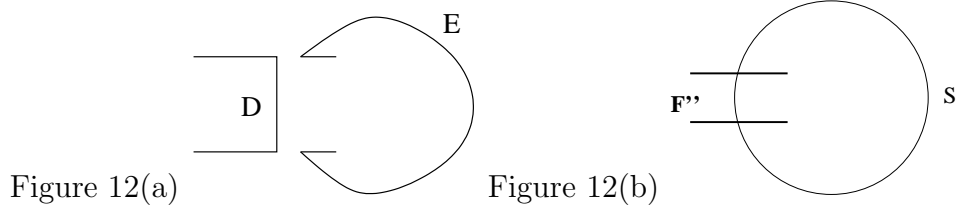
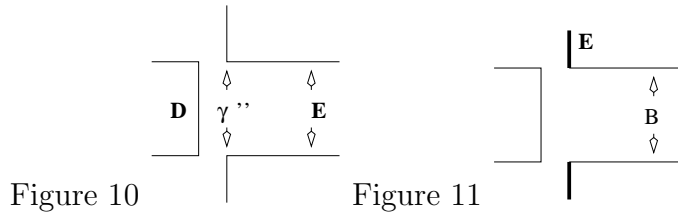

$D \not\subset E$ Regular switch along γ , see Figure 12a. Doing regular switches along $\Gamma - \gamma$: see Figure 12b. So, we get $F = F'' + S$, S a non-separating 2-sphere. Therefore, $w(S) < w(F)$, a contradiction.

$D \subset E$ Let $P = B \cup D = P^2$. Doing regular switches along $\Gamma - \gamma$, we get immersed normal surface F' . Doing a regular switch on F' along γ yields F , and an irregular switch along γ yields a surface, one of whose components is P (see Figure 13). By Lemma 3.5, P is isotopic to some P' with $w(P') < w(F)$, contradicting the definition of F .

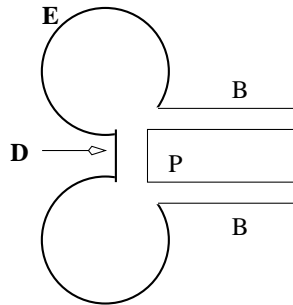

Figure 13

■

Theorem (Rubinstein: 1994). *There exists an algorithm to decide whether or not a given closed 3-manifold is homeomorphic to S^3 . Let \mathfrak{R} denote this algorithm.*

Corollary. *There exists an algorithm to decide whether or not a given 2-sphere in a 3-manifold is geometrically essential.*

Theorem 4.2. *There exist algorithms which take an arbitrary 3-manifold M and*

1. *decide whether or not M is irreducible.*
2. *find a maximal independent system of 2-spheres in M .*
3. *decide whether or not M is prime.*
4. *find the prime decomposition of M .*

Proof of 1. Given a triangulation T of M .

- (i) Write down the matching equations.
- (ii) Find a fundamental set of solutions.
- (iii) Find those that correspond to embedded normal surfaces, *fundamental surfaces*.
- (iv) Find all fundamental surfaces with $\chi > 0$.
 - (a) If none, then M is irreducible by Lemma 4.1.
 - (b) If there exists a fundamental surface P with $\chi(P) = 1$, then $P \cong P^2$, and $N(P) \cong P^3 - \text{Int}B^3$. Therefore, $M \cong M' \# P^3$. Now use \mathfrak{R} to decide whether or not $M' \cong S^3$. If YES, then $M \cong P^3$ (irreducible). If NO, then M reducible.
 - (c) If not (a) or (b), there exist fundamental surfaces S_1, \dots, S_n with $\chi(S_i) = 2$; $S_i \cong S^2$. If some S_i is nonseparating, then M is reducible. If all S_i separate, then S_i gives us $M \cong M'_i \# M''_i$. Apply \mathfrak{R} : if for some i , $M'_i \not\cong S^3 \not\cong M''_i$, then M is reducible. If not, then M is irreducible (by Lemma 4.1).

■

5 Deciding Boundary Compressibility; The Knot Triviality Problem

Let M be a compact, orientable 3-manifold with boundary, T a triangulation of M . The theory of normal surfaces carries over to properly embedded surfaces $F \subset M$ ($F \cap \partial M = \partial F$). For the matching equations, we consider only 2-simplices not in ∂M . The Haken Sum is now performed along simple closed curves and properly embedded arcs.

Definition. A *compressing disk* for ∂M is a properly embedded disk $D \subset M$ such that ∂D does not bound a disk in ∂M . If such a disk exists, ∂M is *compressible*. If not, and no component of ∂M is S^2 , ∂M is *incompressible*.

Let F be a properly embedded surface in M , $\partial F \neq \emptyset$. Let $D \subset M$ be a disk such that

$$D \cap F = \partial D \cap F = \alpha$$

$$D \cap \partial M = \partial D \cap \partial M = \beta$$

with α, β arcs; $\alpha \cup_{\partial} \beta = \partial D$. Then we can do a *boundary surgery* of F along D :

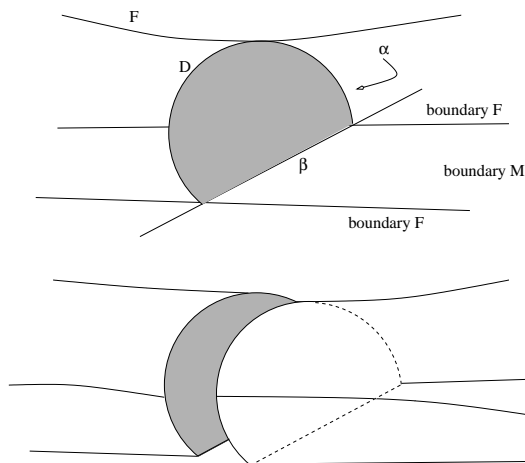

Definition. If we have such a D such that no component of F/α is a disk, then D is a *boundary compressing disk* for F , and we say that F is *boundary compressible*. If F is not ∂ -compressible, then F is *∂ -incompressible*.

Normal surfaces can be used to prove an analog of the Haken finiteness theorem for surfaces with boundary.

Theorem. *Let M be a compact orientable 3-manifold with incompressible boundary. Then there exist $h(M)$ such that if F is an incompressible ∂ -incompressible surface in M , no pair of components of which are parallel, then $|F| \leq h(M)$.*

Proof. Exercise. ■

Exercise: Let M be a handlebody (at least genus 2). For all n , show that there exists an incompressible surface F (properly embedded) in M with $|F| > n$, no pair of components of which are parallel.

Proof of the theorem uses the following:

Lemma. *Let M be a compact orientable 3-manifold with incompressible boundary, $F \subset M$ incompressible ∂ -incompressible. Then M contains such a surface that is normal.*

Proof. Exercise. ■

Lemma 5.1. *Let M be a 3-manifold. Let E be a compressing disk for ∂M . Suppose $E' \sqcup E''$ is obtained from E by ∂ -surgery along a disk. Then, either E' or E'' is a compressing disk for ∂M*

Proof. Let $\gamma = \partial E$, $\gamma' = \partial E'$, $\gamma'' = \partial E''$. Suppose that neither E' nor E'' is a compressing disk, i.e. $\gamma' = \partial\Delta'$, $\gamma'' = \partial\Delta''$, Δ', Δ'' disks in ∂M .

There are two cases:

1. $\Delta' \cap \Delta'' = \emptyset$, $\gamma = \partial\Delta$, $\Delta = \Delta' \cup_{\beta} \Delta''$
2. $\Delta' \subset \Delta''$

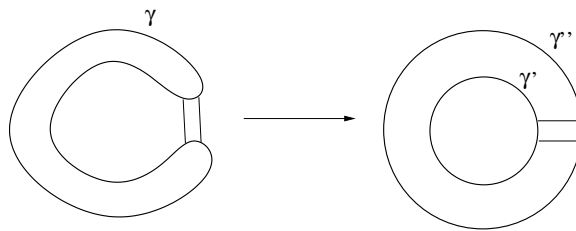

And in either case $\gamma = \partial\Delta$, Δ a disk in ∂M , a contradiction. ■

Lemma 5.2. *Let M be a compact 3-manifold. If ∂M is compressible, then there exists a compressing disk E , with $w(E)$ minimal over all compressing disks, which is a normal surface.*

Proof. Let E be a compressing disk for ∂M with minimal weight. Let Δ be a 2-simplex of T . Consider $E \cap \Delta$.

1. We can assume no component of $E \cap \Delta$ is a 0-gon. Otherwise, let γ be an innermost such. Then $\gamma = \partial D$, D a disk in Δ , with $\text{int} D \cap E = \emptyset$. If $\Delta \subset \partial M$, then $\gamma = \partial E$, contradicting the definition of the compressing disk. So $\Delta \not\subset \partial M$. Surger E along D to obtain $E' \sqcup S$, E' a disk with $\partial E' = \partial E$, and $S \cong S^2$. Then $w(E') \leq w(E)$.
2. No component of $E \cap \Delta$ is an arc with both endpoints in the same edge. Otherwise, let α be an outermost such. Then $\partial\alpha$ is contained in an edge e , $\alpha \cup \tilde{e}$ bounds a disk $D \subset \Delta$, \tilde{e} an arc contained in e with $\partial\tilde{e} = \partial\alpha$, and there are three cases to consider:
 - (a) $e \not\subset \partial M$. Then we can isotop E across D to reduce $w(E)$, a contradiction.
 - (b) $\Delta \subset \partial M$. Again, we can isotop E across D to reduce $w(E)$.
 - (c) $e \subset \partial M$, $\Delta \not\subset \partial M$. We perform ∂ -surgery on E along D which yields $E' \sqcup E''$. By Lemma 5.1, E' , say, is a compressing disk and $w(E') < w(E)$, a contradiction.
3. Let τ be a 3-simplex of T . Each component of $E \cap \partial\tau$ meets any edge at most once. Suppose not. So, there exists a disk $D' \subset \partial\tau$ such that $\partial D' = \alpha' \cup \beta$, $\beta \subset e$, $\alpha' \subset E \cap \partial\tau$. Near e , α' is contained in a 2-simplex Δ . Let $\delta \subset \Delta$ be β pushed slightly into Δ . Let $D \subset \tau$ be a suitable parallel copy of D' ; D is D' "tilted about δ ". If $\Delta \not\subset \partial M$, use D to isotop E to E' , then apply 2.

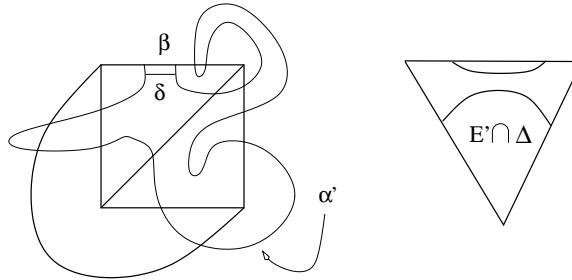

If $\Delta \subset \partial M$, perform a ∂ -surgery along D to obtain $E' \sqcup E''$ with E' , say, a compressing disk with $w(E') < w(E)$, a contradiction. ■

Theorem 5.3. *Let M be a compact orientable 3-manifold. If ∂M is compressible, then there exists a compressing disk for ∂M which is a fundamental surface.*

Proof. Let F be a compressing disk for ∂M , with $w(F)$ minimal over all compressing disks, which is normal.

CLAIM: F is fundamental.

Proof of Claim: Suppose not. So, $F = G + H$ ($G, H \neq \emptyset$). Now, $G \cap H$ is a disjoint union of simple closed curves and properly embedded arcs. We may choose such G and H so that $|G \cap H|$ is minimal. Analogs of Lemma 3.4 hold, and, in particular, G and H are connected. Now,

$$1 = \chi(F) = \chi(G) + \chi(H)$$

Therefore, $\chi(G)$, say, is greater than zero. So, $G \cong P^2, S^2, D^2$.

Case I, $G \cong P^2$ Note that $\chi(H) = 0$ and since $\partial G = \emptyset$ and $|\partial F| = 1$ and $|\partial H| = 1$, H is a Mobius band. Let γ be a component of $\Gamma = G \cap H$. Now, γ is 2-sided in G iff γ is 2-sided in H , as M is orientable. So, if γ is 2-sided in G , then γ is separating in G and H , since G is a projective plane and H is a Mobius band, and this contradicts Lemma 3.4. Therefore, γ is 1-sided in G and H . So, since γ is a simple closed curve in G and H , it is the only component of $G \cap H$, as there is only one 1-sided simple closed curve in G and H , up to isotopy. Now, performing an irregular switch at γ on $G \cup H$ yields a connected surface F' , with nonempty boundary, such that $\chi(F') = 1$. So, F' is a disk. But, by Lemma 3.5, F' may be isotoped to F'' so that $w(F'') < w(F)$, and since $\partial F' = \partial F$, F'' is a compressing disk, contradicting the minimality of $w(F)$.

Case II, $G \cong S^2$ Let D be a disk region of $G \cup H$ in G , $\partial D = \gamma$. Regular switches along $\Gamma = G \cap H$ yields $F \cong D^2$, and so D gives rise to a disk D' in F . So, γ'' bounds a disk $E \subset F$.

(i)

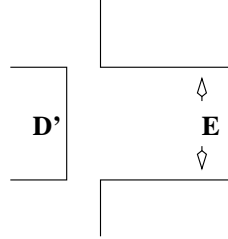

Proceed as in proof of Lemma 4.1. Since γ separates G , γ does not separate H , by Lemma 3.4. Therefore, E is not a region. So, E contains a disk region $\tilde{D} \subset G$. If (i) holds for \tilde{D} , continue. Eventually, we get a cycle

$$D_0, E_0, \dots, E_{k-1} \supset D_0$$

Now, replacing E_i with D_i , $0 \leq i \leq k-1$, we have a disk F' that is disk-equivalent to F with $F = F' + F''$ and $w(F') < w(F)$, a contradiction:

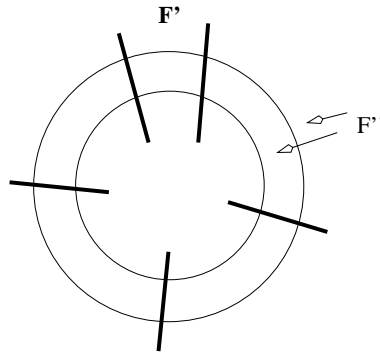

Note: We don't have to treat the case $k = 1$ separately.

(ii) Let D' be as above, $\partial D' = \gamma'$, D'' the parallel copy of D with $\partial D'' = \gamma'' \subset F$. Let E' be a parallel copy of E with $\partial E' = \gamma'$.

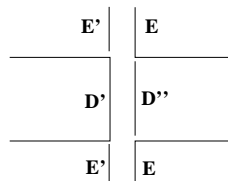

$D' \not\subset E$ Replace E with D'' in F . Then replace D' with E' . Call the resulting surface B . Now perform regular switches on $G \cup H$ along $\Gamma - \gamma$ to obtain an immersed surface F' . Now, an irregular switch along γ on F' yields B , and so B is isotopic to B' with $w(B') < w(F)$, B disk equivalent to F , a contradiction.

$D' \subset E$

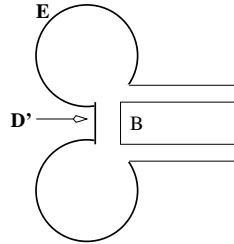

Note that $B = (F - E) \cup D''$ is a disk with $\partial B = \partial F$. Perform regular switches along all components of Γ except γ to obtain an immersed surface F' . Now, a regular switch at γ on F' yields F , and an irregular switch at γ yields a surface, one component of which is B . By Lemma 3.5, we can isotop B to B' with $w(B') < w(F)$, a contradiction.

Case III, $G \cong D^2$

$$1 = \chi(F) = \chi(G) + \chi(H)$$

and since $\chi(G) = 1$, $\chi(H) = 0$. If $\partial H = \emptyset$, then $\partial F = \partial G$, and then G is a compressing disk with $w(G) < w(F)$, a contradiction. If $\partial H \neq \emptyset$, then H is an annulus or a Mobius band. Suppose γ is a simple closed curve component of Γ , γ separating G . Also, M being orientable and γ 2-sided in G implies that γ is 2-sided in H . So, γ separates H . This contradicts the minimality of Γ , by Lemma 3.4. So, Γ is a disjoint union of arcs.

Let D be an outermost disk region in G corresponding to an arc

component $\alpha \in \Gamma$.

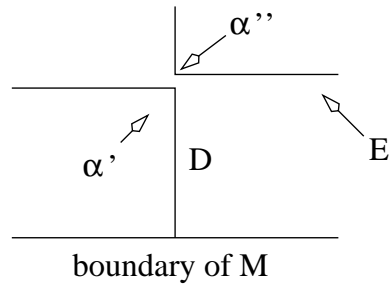
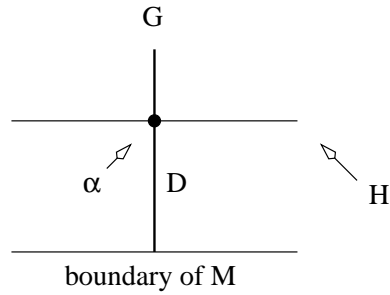
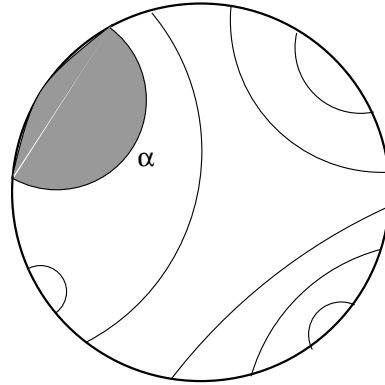

Now, α'' is an arc in F and so α'' separates F into two disks, E and E' . Let E be the disk shown. Now, α separating in G implies that α does not separate H , and so E contains a disk region. As before, we get a cycle

$$D_0, E_0, \dots, E_{k-1} \supset D_0 \quad (k \geq 1)$$

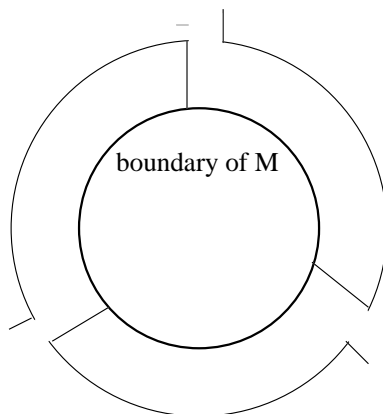

$k \geq 2$

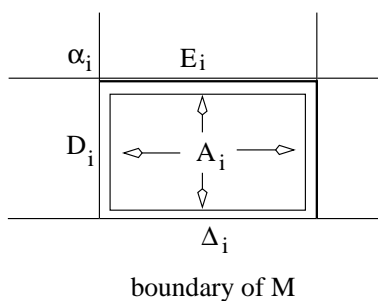

Let $A_i = D_i \cup_{\alpha_i} E_i$. Now, perform regular switches on all components of Γ to obtain an immersed surface F_i . Now, performing a regular switch at α_i yields F , and an irregular switch yields a surface, one component of which is A_i . By Lemma 3.5, A_i is isotopic to A'_i with $w(A'_i) < w(F)$. So, A_i is not a compressing disk, i.e. ∂A_i bounds a disk $\Delta_i \subset \partial M$. Then $A_i \cup \Delta_i \cong S^2$. *Note:* D_i is as shown, otherwise $\partial F \subset \Delta_i$, a contradiction. So, F is isotopic to $F \cup \Delta_i$ and we can replace the disk $E_i \cup \Delta_i$ with D_i , $1 \leq i \leq k - 1$, to obtain a surface F' with

$F = F' + F''$, $w(F') < w(F)$, a contradiction.

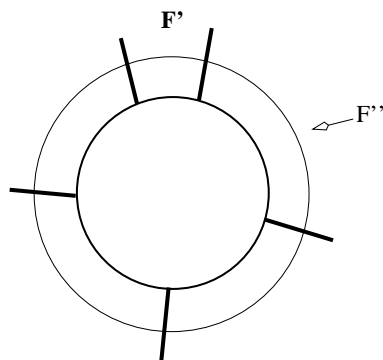

$k = 1$

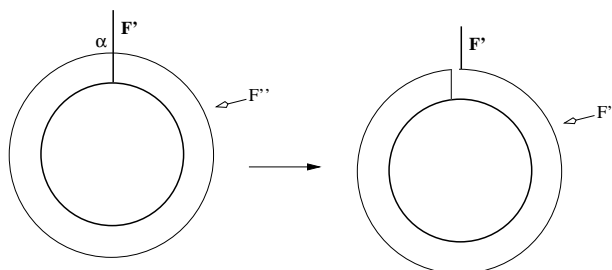

Perform regular switches along $\Gamma - \alpha$ to obtain an immersed surface F' . Now, a regular switch at α on F' yields F and an irregular switch at α on F' yields a disk F'' with $\partial F'' = \partial F$, F'' isotopic to F''' with $w(F''') < w(F)$, a contradiction.

■

Corollary 5.4. *There exists an algorithm to decide whether or not a given compact 3-manifold has compressible boundary.*

Proof. Exercise.

■

Hence,

Theorem 5.5 (Haken: 1962). *There exists an algorithm to decide whether or not a given knot is trivial.*

Let $K \subset S^3$ be a knot. Then K is trivial iff it is isotopic to \bigcirc . Let M_K denote the exterior of K , i.e. $M_K = S^3 - \text{int}N(K)$.

Lemma 5.6. *Let μ be a meridian of $\partial N(K)$. Then $H_1(M_K) \cong \mathbb{Z}$ is generated by $[\mu]$.*

Proof. $S^3 = M_K \cup_{\partial N} N$, $N = N(K)$. The Mayer-Vietoris exact sequence gives us:

$$H_2(S^3) \rightarrow H_1(\partial N) \rightarrow H_1(M_K) \oplus H_1(N) \rightarrow H_1(S^3)$$

Now, $H_1(\partial N) \cong \langle [\mu], [\lambda] \rangle = \mathbb{Z} \oplus \mathbb{Z}$ where $\lambda \in \partial N$ is a simple closed curve such that $[\lambda][\mu] = 1$. Now, $[\mu]$ maps to zero in $H_1(N)$, $[\lambda]$ maps to 1. Now, the map $H_1(\partial N) \rightarrow H_1(M_K) \oplus H_1(N)$ is surjective and so we have:

$$(1, 0) = a(i_*[\mu], 0) + b(x, 1)$$

where $[\lambda] \mapsto (x, 1)$. So, $b = 0$ and $i_*[\mu] = \pm 1$. So, $i_*[\mu]$ generates $H_1(M_K) \cong \mathbb{Z}$. ■

Note: M_K is irreducible by Alexander's Theorem.

Theorem 5.7. *Let K be a knot in S^3 . Then the following are equivalent:*

- (i) K is trivial.
- (ii) $M_K \cong S^1 \times D^2$.
- (iii) ∂M_K is compressible.

Proof. (i) \Rightarrow (ii) \Rightarrow (iii). Clear. (iii) \Rightarrow (i). Let D be a compressing disk for ∂M_K . Let μ be a meridian, λ the latitude of K , i.e. λ is a simple closed curve in ∂N , $[\lambda][\mu] = 1$, and $\lambda \sim 0$ in M_K . Now,

$$[\partial D] = p[\lambda] + q[\mu], \quad (p, q) = 1$$

but $[\partial D] = 0$ in $H_1(M_K)$ and since

$$[\lambda] \mapsto 0 \text{ and } [\mu] \mapsto \text{generator}$$

in $H_1(M_K)$, $q = 0$, $p = \pm 1$. Therefore, ∂D is isotopic to λ in ∂N . Therefore, there exists an annulus $A \subset N$ such that $\partial A = K \sqcup \partial D$. Therefore, $D^+ = D \cup A$ is a disk in S^3 with $\partial D^+ = K$. So, K is trivial.



Theorem 5.7 and Corollary 5.4 imply Theorem 5.5.

Question: Is there a polynomial time algorithm for this?

6 Deciding the Existence of Incompressible Surfaces

Note: Let M be a closed orientable 3-manifold. Let G be a connected non-orientable surface in M , then $N(G)$ is a twisted I -bundle over G , and $\partial N(G)$ is a 2-fold orientation preserving cover of G .

Theorem 6.1 (Jaco, Oertel: 1984). *Let M be a closed 3-manifold that contains an orientable incompressible surface F . Then M contains such a surface that is either fundamental or $\partial N(G)$, where G is non-orientable and fundamental.*

Proposition 6.2. *Let M be a closed 3-manifold, F incompressible surface (not necessarily connected) in M , which is of least weight among all disk-equivalent surfaces in M . Suppose $F = G + H$ with G, H normal. Then G and H are incompressible.*

Lemma 6.3. *Let $F = G + H$ as in Proposition 6.2. Then no region of $G \cup H$ is a disk.*

Proof. Let $\Gamma = G \cap H$. Let D be a disk region in G , say. So, D yields a disk $D' \subset F$ with $\partial D' = \gamma'$. Now, there exists a disk D'' , a parallel copy of D in M such that $D'' \cap F = \partial D'' = \gamma''$. Now, since F is incompressible, $\gamma'' = \partial E$, E a disk in F .

1

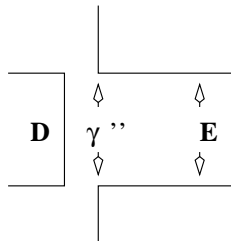

Exercise (Compare earlier arguments: E cannot be a region, so we obtain a cycle, et cetera).

2 Let D', D'' be as above. Let E' be a parallel copy of E with $\partial E' = \gamma'$.

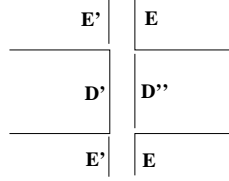

$D' \not\subset E$ Replace E with D'' in F . Then replace D' with E' . Call the resulting surface B . Now perform regular switches on $G \cup H$ along $\Gamma - \gamma$ to obtain an immersed surface F' . Now, an irregular switch along γ on F' yields B , and so B is isotopic to B' with $w(B') < w(F)$, B disk equivalent to F , a contradiction.

$D' \subset E$ Replace E with D'' to obtain $F'' = (F - E) \cup D''$. Doing regular switches along $\Gamma - \gamma$ yields an immersed normal surface F' , say. Now, performing a regular switch at γ on F' yields F and an irregular switch at γ yields a surface with F'' as a component. So, by Lemma 3.5, F'' is isotopic to some F''' with $w(F''') < w(F)$. But, F'' is isotopic to F , and we have a contradiction.

■

Lemma 6.4. *Each region of $G \cup H$ is incompressible in M .*

Proof. Let R be a region of $(G \cup H)/\Gamma$. Let $D \subset M$ be a disk such that $D \cap R = \partial D$. Now, $R \subset F$, F is incompressible, and so ∂D bounds a disk $E \subset F$. Suppose $E \not\subset R$. Then E contains a disk region of $(G \cup H)/\Gamma$, contradicting Lemma 6.3. Therefore, $E \subset R$ and so R is incompressible.

■

PROOF OF PROPOSITION 6.2: Suppose $F = G + H$ and, without loss of generality, assume $|G \cap H|$ minimal over all G', H' disk-equivalent to G, H with $F = G' + H'$. Now, G , say, is compressible, and let D be a compressing disk for G with $|D \cap H|$ minimal.

CLAIM 1: $D \cap H \neq \emptyset$.

Proof of Claim 1. Suppose $D \cap H = \emptyset$. Then ∂D is contained in some region $R \subset G$. Therefore, by Lemma 6.4, $\partial D = \partial E$, E a disk in $R \subset G$. Therefore D is not a compressing disk for G , a contradiction.

CLAIM 2: No component of $D \cap H$ is a simple closed curve.

Proof of Claim 2. Suppose there is such a component. Then an innermost such in D bounds a disk $D_0 \subset D$. Now, ∂D_0 is contained in some region $R \subset H$, and by Lemma 6.4, $\partial D_0 = \partial E$, E a disk in R .

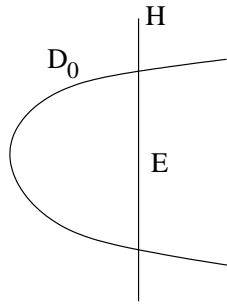

Now, replace D_0 with E and then we can isotop the resulting D' to D'' so that $|D'' \cap H| < |D \cap H|$, a contradiction.

So, $D \cap H$ is a disjoint union of properly embedded arcs. So, we have the following diagram:

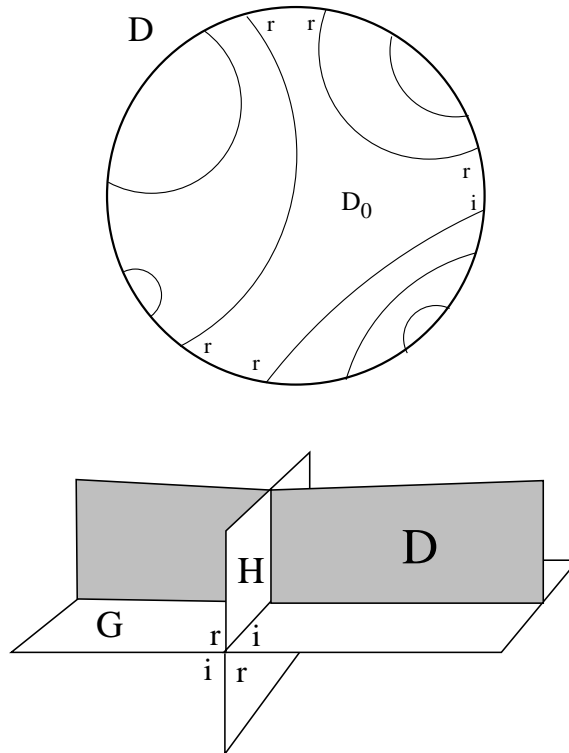

where the corners of $G \cap H$ are labelled r for a regular switch, and i for an irregular switch as in Chapter 3.

CLAIM 3: There exists a component of $D/(D \cap H)$ with at most one i -label. *Proof of Claim 3.* Let $n = |D \cap H|$. Then $D/(D \cap H)$ has $(n + 1)$ components. Also, there are $2n$ i -labels and $2n$ r labels. Therefore there exists a component of $D/(D \cap H)$ with at most one i -label.

Let D_0 be such a component.

Case I There exists a D_0 with no i -label. Do all of the regular switches on $\Gamma = G \cap H$ to obtain F .

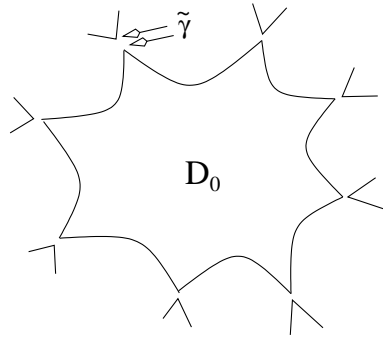

Regard D_0 as a disk in M with $D_0 \cap F = \partial D_0$. Since F is incompressible, $\partial D_0 = \partial E$, E a disk in F . For γ a component of $G \cap H$, let $\tilde{\gamma}$ be the image of γ in F . Let

$$\tilde{\Gamma} = \bigcup_{\gamma \text{ comp't of } G \cap H} \tilde{\gamma}.$$

Note: $F/\tilde{\Gamma} = (G \cup H)/\Gamma$. Consider $E \cap \tilde{\Gamma}$. By Lemma 6.3, $F/\tilde{\Gamma}$ has no disk regions, and so $E \cap \tilde{\Gamma}$ is a disjoint union of properly embedded arcs. Let E_0 be an outermost component of $E/(E \cap \tilde{\Gamma})$. Now, $\partial E_0 = \alpha \cup \beta$, $\beta \subset \partial E$, $\alpha \subset \tilde{\Gamma}$.

subcase i, $E_0 \subset G$ Isotop D by pushing β along E_0 to α , and slightly beyond to obtain a D' with $|D' \cap H| < |D \cap H|$, a contradiction:

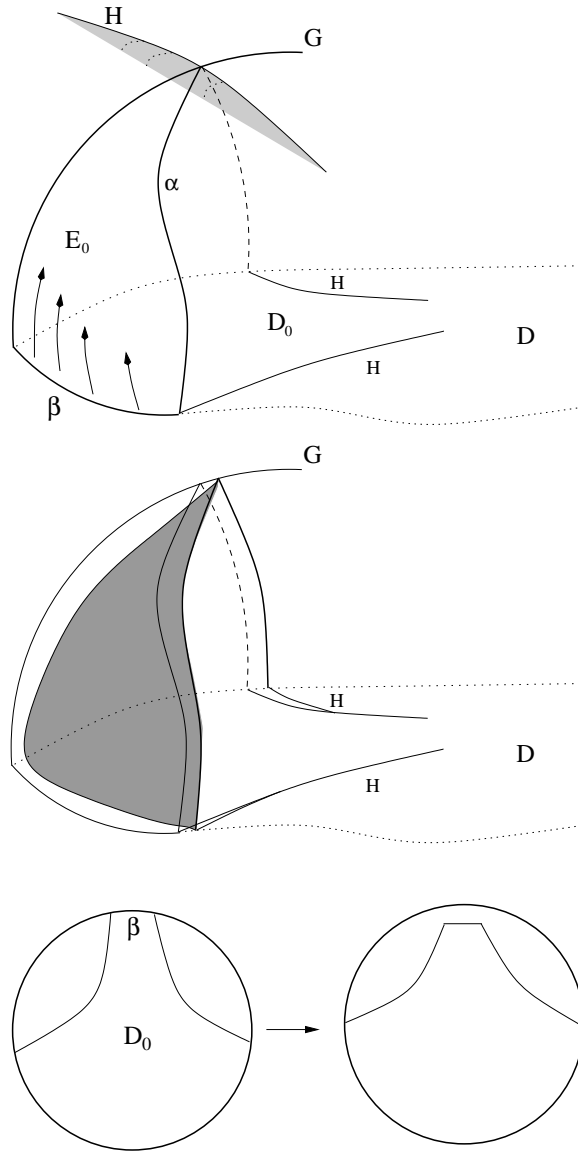

subcase ii, $E_0 \subset H$

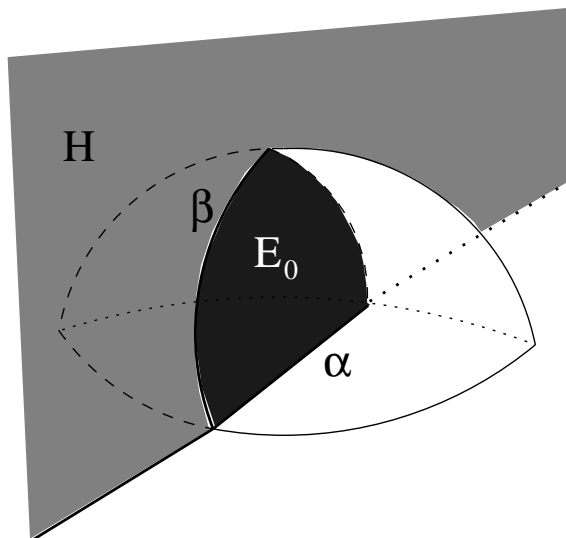

Perform boundary surgery on D along E_0 to obtain $D' \sqcup D''$. So, D' , say, is a compressing disk for G and $|D' \cap H| < |D \cap H|$, a contradiction.

Case II There exists a D_0 with exactly one i -label.

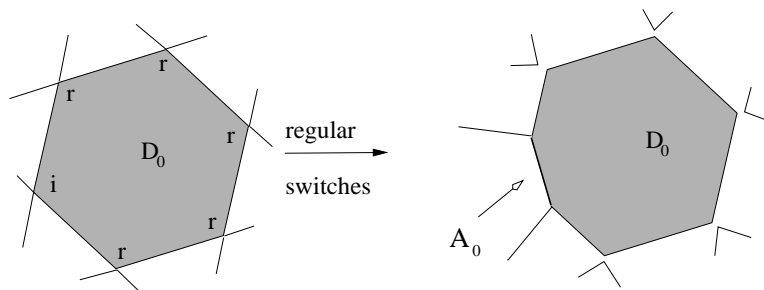

Let γ be the component of $G \cap H$ corresponding to the i -label in D_0 .

subcase i Suppose γ is 2-sided in G and H . Then there exists an annulus $A_0 \subset M$ with $A_0 \cap F = \partial A_0 = \tilde{\gamma} = \gamma' \sqcup \gamma''$. Note: F is 2-sided in M , and D_0 and A_0 lie on the same side of F .

Therefore γ meets ∂D_0 only at the corner corresponding to the i -label. So, regard D_0 as a disk in M with

$$D_0 \cap F = \partial D_0 \cap F = \delta,$$

$$\text{and } D_0 \cap A_0 = \partial D_0 \cap A_0 = \varepsilon$$

δ, ε arcs.

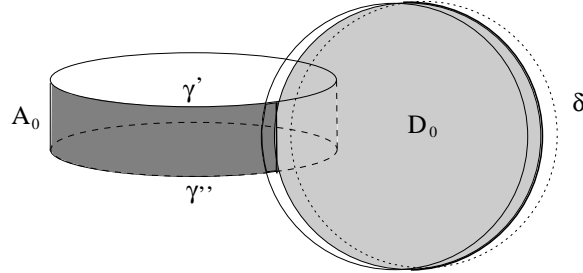

So, $\delta \cup \varepsilon = \partial D_0$. Let $N(D_0) \cong D_0 \times [-1, 1]$ be a neighborhood of D_0 such that

$$N(D_0) \cap F = \delta \times [-1, 1]$$

$$\text{and } N(D_0) \cap A_0 = \varepsilon \times [-1, 1].$$

Let $D_0^\pm = D_0 \times \{\pm 1\}$, $\delta^\pm = \delta \times \{\pm 1\}$. Let

$$\omega = (\gamma' \cup \gamma'' - N(\varepsilon)) \cup \delta^+ \cup \delta^-$$

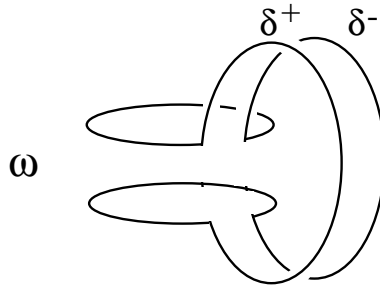

Now, ω is a simple closed curve in F , and $\omega = \partial\Omega$, where Ω is the disk

$$\Omega = (A_0 - N(\varepsilon)) \cup D_0^+ \cup D_0^-$$

and $\Omega \cap F = \partial\Omega = \omega$. Since F is incompressible, $\omega = \partial E$, E a disk in F .

Suppose $N(\delta) \subset E$.

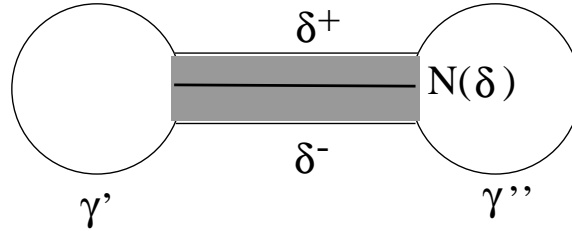

Then γ', γ'' would bound disks in F , and so F would contain a disk region, a contradiction. So $N(\delta) \not\subset E$. Then $A = E \cup N(\delta)$ is an annulus in F , as F is orientable. Now, $\partial A = \gamma' \sqcup \gamma''$ and so $T = A \cup A_0$ is a torus. (*Exercise:* Why not a Klein Bottle?). Now, D_0 is a compressing disk for T , and so we may isotop F so that $N(\delta) \subset N(\varepsilon) = A_0$. Let $\Delta = A - N(\delta)$, $\Delta_0 = A_0 - N(\varepsilon)$. We perform a disk replacement in order to obtain $F_0 = (F - \Delta) \cup \Delta_0$. Now, F_0 is incompressible and, performing regular switches along all components of Γ except γ yields an immersed normal surface F' . Performing a regular switch at γ on F' yields F , and performing an irregular switch at γ on F' yields a surface which has F_0 as a component. Therefore we may isotop F_0 to F_1 with $w(F_1) < w(F)$. Since F_0 is disk-equivalent to F , this contradicts the minimality of $w(F)$.

subcase ii Suppose γ is 1-sided in G and H . Then we have $\tilde{\gamma} = \partial B$, B a Mobius band. Let A_0 be the annulus parallel to B and proceed as in subcase (i).

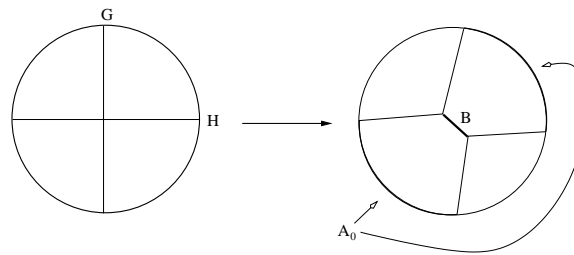

■

PROOF OF THEOREM 6.1. Let F be an orientable, incompressible surface, $w(F)$ minimal among all disk-equivalent surfaces in M , and normal.

Suppose F not fundamental. So, $F = \sum_{i=1}^k G_i$, G_i are fundamental, and so $F = \sum_{i=2}^k G_i = G + H$, G fundamental. By Proposition 6.2, G is incompressible. If G is orientable, then we are done. If G is non-orientable, consider

$$2F = 2G + 2H,$$

and note that $2G = \partial N(G)$ is an orientable surface. So, since $w(2F) = 2w(F)$ and $w(F)$ is minimal in the above sense, $w(2F)$ is minimal in the equivalence class of $2F$ as F is orientable. By Proposition 6.2, $2G$ is incompressible. ■

Theorem 6.5. *There is an algorithm to decide whether or not a given closed irreducible 3-manifold M contains an incompressible orientable surface.*

Proof. By Theorem 6.1, if M contains an incompressible surface, then it contains one that is either fundamental of $\partial N(G)$, G non-orientable and fundamental. Now, find all fundamental surfaces F_1, \dots, F_n . Let

$$F'_i = \begin{cases} F_i & \text{if } F_i \text{ is orientable} \\ \partial N(F_i) & \text{if } F_i \text{ is non-orientable} \end{cases}$$

and let $M_i = M/F'_i$. Now, F'_i is incompressible in M if and only if ∂M_i is incompressible in M_i , and this is a decidable condition. Now, ∂M_i is compressible if and only if there is a fundamental compressing disk, and we're done. ■

Theorem 6.6. *Let M be a closed irreducible, atoroidal 3-manifold. Let $g \geq 2$. Then M contains only finitely many isotopy classes of orientable incompressible surfaces of genus g .*

Proof. Let F be an incompressible surface of genus g in M . Then $F = \sum_{i=1}^k F_i$, F_i fundamental (and connected). Choose F in its isotopy class to have minimal weight. By Lemma 6.3, we can assume that no region is a disk. So, no F_i is a sphere. Similarly, $2F = \sum_{i=1}^k 2F_i$, $F_i \not\cong P^2$, $i = 1, \dots, k$. So, $\chi(F_i) \leq 0$, $i = 1, \dots, k$. By Lemma 6.4, F_i is incompressible, $i = 1, \dots, k$, and similarly, $2F_i$ incompressible. Since M is atoroidal, $F_i \not\cong T^2$ and $2F_i \not\cong T^2$, i.e. $F_i \not\cong$ Klein Bottle.

So, $\chi(F_i) < 0$, $i = 1, \dots, k$. Since there are only finitely many fundamental surfaces, for a given $e > 0$, there are only finitely many (F_1, \dots, F_k) , F_i fundamental and $\sum_{i=1}^k \chi(F_i) = e$. So, there are only finitely many incompressible $F = \sum_{i=1}^k F_i$. ■

7 Haken Manifolds and Hierarchies

Definition. A *hierarchy* for a 3-manifold M is a sequence $M = M_1, M_2, \dots, M_n$ where $M_{i+1} = M_i/F_i$, F_i a properly embedded orientable incompressible surface in M_i and $M_n = \sqcup B^3$'s. A *partial hierarchy* is a sequence as above without the assumption that $M_n \cong \sqcup B^3$'s.

ANALOG IN DIMENSION 2

Let F be a compact surface. A *hierarchy* for F is a sequence $F = F_1, \dots, F_n$ where $F_{i+1} = F_i/\gamma_i$, γ_i an arc or simple closed curve in F_i and $F_n = \sqcup D^2$'s. Any compact surface F has a hierarchy if $F \not\cong S^2$ and, in fact, if we always choose γ_i so that

1. γ_i is not a simple closed curve bounding a disk in F_i ,
2. γ_i is not a simple closed curve parallel to a component of ∂F_i ,
3. γ_i is not an arc parallel into ∂F_i .

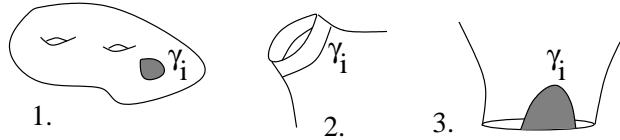

Then the sequence F_i, \dots terminates with $F_n = \sqcup D^2$'s (Exercise).

DIMENSION 3

In dimension 3, the definition given does not guarantee that the process terminates.

EXAMPLE: Let M be a handlebody of genus $k + 1$

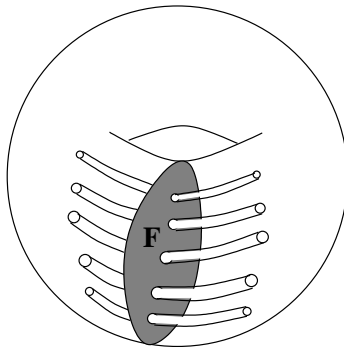

The surface $F \subset M$ as shown in the figure is incompressible, and M/F is a handlebody of genus $2k$:

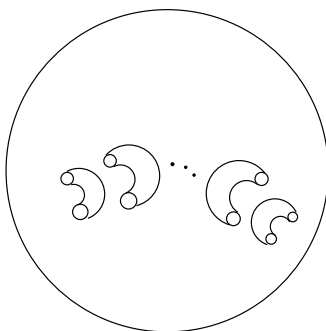

But, of course, a handlebody does have a hierarchy:

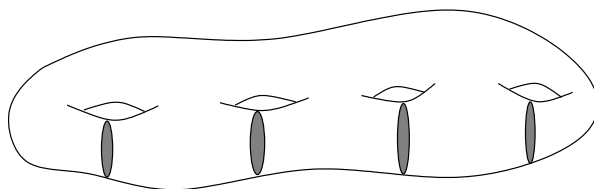

Recall:

Definition. A compact 3-manifold M is *Haken* if M is irreducible and contains an 2-sided incompressible surface.

Remark. We could allow M to be non-orientable and require the F_i above to be 2-sided incompressible surfaces. But, (exercise), if M is a closed non-orientable 3-manifold, then $H_1(M)$ is infinite, and so M contains a closed 2-sided incompressible surface. So, every closed non-orientable 3-manifold is Haken.

Now, if M has a hierarchy, then $M \cong B^3$ or M contains an incompressible surface. Also, if F is incompressible in M , then M/F is irreducible if and only if M is irreducible (exercise). Conversely, we have

Theorem 7.1. *A Haken 3-manifold has a hierarchy.*

Definition. Let G be a group. A $K(G, 1)$ is a path connected space K s.t. $\pi_1(K) \cong G$ and $\pi_i(K) = 0$, $i \geq 2$.

For example, S^1 is a $K(\mathbb{Z}, 1)$.

Lemma 7.2. *Let X be a path connected finite simplicial complex and let $\varphi : \pi_1(X) \rightarrow G$ be a homomorphism. Let K be a $K(G, 1)$. Then there exists a map $f : X \rightarrow K$ such that $\varphi = f_* : H_1(X) \rightarrow H_1(K)$.*

Proof. Let $X^{(i)}$ be the (i) -skeleton of X . We define f inductively on $X^{(i)}$. Let T be a maximal tree in $X^{(1)}$. Let k_0 be a basepoint of K . Define $f(T) = k_0$. Let $\sigma^{(1)}$ be a 1-simplex in $X^{(1)} - T$. So, $\sigma^{(1)}$ represents an element $[\sigma^{(1)}] \in \pi_1(X)$. Define f on $\sigma^{(1)}$ such that $[f(\sigma^{(1)})] = \varphi[\sigma^{(1)}] \in \pi_1(K, k_0) = G$. This defines f on $X^{(1)}$. Let $\sigma^{(2)}$ be a 2-simplex in X . We have f defined on $\partial\sigma^{(2)}$. Also, $[\partial\sigma^{(2)}] = 1 \in \pi_1(X)$. Therefore, $[f(\partial\sigma^{(2)})] = \varphi(1) = 1 \in \pi_1(K)$. Therefore, $f|_{\partial\sigma^{(2)}}$ extends to $f : \sigma^{(2)} \rightarrow K$. So, f is defined on $X^{(2)}$. Let $\sigma^{(3)}$ be a 3-simplex in X . We have f defined on $\partial\sigma^{(3)}$. Now, $\pi_2(K) = 0$ implies that $f|_{\partial\sigma^{(3)}} : \partial\sigma^{(3)} \rightarrow K$ extends to $f : \sigma^{(3)} \rightarrow K$. So, f can be defined on $X^{(3)}$, and so on. ■

Lemma 7.3. *Let*

$$0 \rightarrow V_1 \rightarrow V_2 \rightarrow \cdots \rightarrow V_n \rightarrow W \xrightarrow{\varphi} W \rightarrow \cdots \rightarrow V_2 \rightarrow V_1 \rightarrow 0$$

be an exact sequence of finite dimensional vector spaces. Then

$$\dim(\ker \varphi) = \frac{1}{2} \dim W.$$

Proof. We get exact sequences

$$0 \rightarrow V_1 \rightarrow V_2 \rightarrow \cdots \rightarrow V_n \rightarrow \ker \varphi \rightarrow 0$$

and

$$0 \rightarrow \operatorname{im} \varphi \rightarrow V_n \rightarrow \cdots \rightarrow V_1 \rightarrow 0$$

Therefore, by Lemma 2.4,

$$\dim(\ker \varphi) = \left| \sum_{i=1}^n (-1)^i \dim V_i \right|$$

$$\dim(\operatorname{im} \varphi) = \left| \sum_{i=1}^n (-1)^i \dim V_i \right|$$

and so $\dim(\ker \varphi) = \dim(\operatorname{im} \varphi)$. But, $\dim W = \dim(\ker \varphi) + \dim(\operatorname{im} \varphi)$. ■

Lemma 7.4. *Let M be a compact orientable 3-manifold. Then, with field coefficients,*

$$\dim(\ker(H_1(\partial M) \rightarrow H_1(M))) = \frac{1}{2}H_1(\partial M).$$

Proof. Since we are working with field coefficients, $H^i(M) \cong H_i(M)$, and by Lefschetz Duality, we have $H_i(M) \cong H^{3-i}(M, \partial M) \cong H_{3-i}(M)$. So, in the Homology long exact sequence of the pair $(M, \partial M)$,

$$\begin{aligned} 0 \rightarrow H_3(M) \rightarrow H_3(M, \partial M) \rightarrow H_2(\partial M) \rightarrow H_2(M) \rightarrow H_2(M, \partial M) \rightarrow H_1(\partial M) \\ \xrightarrow{\varphi} H_1(M) \rightarrow H_1(M, \partial M) \rightarrow H_0(\partial M) \rightarrow H_0(M) \rightarrow H_0(M, \partial M) \rightarrow 0 \end{aligned}$$

we have:

$$H_3(M) \cong H_0(M, \partial M)$$

$$H_3(M, \partial M) \cong H_0(M)$$

$$H_2(\partial M) \cong H_0(\partial M)$$

$$H_2(M) \cong H_1(M, \partial M)$$

and

$$H_2(M, \partial M) \cong H_1(M)$$

and so our sequence can be rewritten:

$$\begin{aligned} 0 \rightarrow H_0(M, \partial M) \rightarrow H_0(M) \rightarrow H_0(\partial M) \rightarrow H_1(M, \partial M) \rightarrow H_1(M) \rightarrow H_1(\partial M) \\ \xrightarrow{\varphi} H_1(M) \rightarrow H_1(M, \partial M) \rightarrow H_0(\partial M) \rightarrow H_0(M) \rightarrow H_0(M, \partial M) \rightarrow 0 \end{aligned}$$

Now, by Lemma 7.3, $\dim(\ker \varphi) = \frac{1}{2} \dim H_1(\partial M)$. ■

Remark. The same proof shows that for a compact orientable $(2n+1)$ -manifold,

$$\dim(\ker(H_n(\partial M) \rightarrow H_n(M))) = \frac{1}{2}H_n(\partial M).$$

Corollary 7.5. *Let M be a compact 3-manifold, $\emptyset \neq \partial M \neq \bigsqcup S^2$'s. Then $H_1(M)$ is infinite.*

Proof. Take \mathbb{Q} coefficients. Then $\dim H_1(\partial M; \mathbb{Q}) \geq 2$. Therefore $\dim H_1(M; \mathbb{Q}) \geq 1$. Now, by the Universal Coefficient Theorem, $H_1(M; \mathbb{Q}) \cong H_1(M; \mathbb{Z}) \otimes \mathbb{Q}$, and so $H_1(M; \mathbb{Z})$ is infinite. ■

Lemma 7.6. *Let M be a compact 3-manifold, α, β simple closed curves in ∂M such that $|\alpha \cap \beta| = 1$. Then $[\alpha], [\beta]$ are not both of finite order in $H_1(M)$.*

Proof. Attach handlebodies to all components of ∂M other than the one, say F , which contains α and β . Attach a handlebody V of genus $\text{genus}(F) - 1$ to $F - \overset{\circ}{N}(\alpha \cup \beta)$ along $\partial V - \overset{\circ}{D}^2$. This gives a compact 3-manifold N with $\partial N \cong T^2$, $\alpha, \beta \subset \partial N$. Now, $[\alpha], [\beta]$ both of finite order in $H_1(M)$ implies that $[\alpha], [\beta] = 0$ in $H_1(M; \mathbb{Q})$, which means that $[\alpha], [\beta] = 0$ in $H_1(N; \mathbb{Q})$, and so $H_1(\partial N; \mathbb{Q}) \rightarrow H_1(N; \mathbb{Q})$ is zero, contradicting Lemma 7.4. ■

Lemma 7.7. *Let M be a compact 3-manifold.*

1. *If $H_1(M)$ is infinite, then M contains a non-separating connected surface F that is either incompressible or S^2 .*
2. *If ∂M has a component of genus greater than 0 (in which case $H_1(M)$ is infinite, by Corollary 7.5), then F , as in (1), can be chosen to satisfy $[\partial F] \neq 0$ in $H_1(M)$.*

Proof. 1. Since M is compact, $H_1(M)$ is finitely generated. Therefore, $H_1(M)$ infinite means that $H_1(M) \cong \mathbb{Z} \oplus \dots$. So, there exists an epimorphism $H_1(M) \rightarrow \mathbb{Z}$, and so we get an epimorphism $\varphi : \pi_1(M) \rightarrow \mathbb{Z}$:

$$\begin{array}{ccc}
 H_1(M) & \xrightarrow{\quad} & \mathbb{Z} \\
 & \nwarrow & \nearrow \varphi \\
 & \pi_1(M) &
 \end{array}$$

Now, S^1 is a $K(\mathbb{Z}, 1)$. Therefore, by Lemma 7.2, there exists $f : M \rightarrow S^1$ such that $f_* = \varphi$. Homotop f to be transverse to $\star \in S^1$. Then $f^{-1}(\star) = F^*$ is a two-sided surface in M .

CLAIM: Some component of F^* is nonseparating in M .

Let γ be a simple closed curve in M such that $f_*[\gamma]$ generates $\pi_1(S^1) \cong \mathbb{Z}$. F^* has a neighborhood $N(F^*) \cong F^* \times [-1, 1]$, and $\star \in S^1$ has a neighborhood homeomorphic to $[-1, 1]$ such that $f|_{N(F^*)}$ is given by $(x, t) \mapsto t$. Make $\gamma \pitchfork F^*$. We see that the algebraic intersection number $\gamma \bullet F^* = f(\gamma) \bullet \star = \pm 1$. Therefore, there is a component F of F^* such that $\gamma \bullet F$ is odd. So, F is non-separating. Now, if F is compressible, then surgering F along a compressing disk gives F' . Some component of F' is non-separating (exercise). Hence, we eventually get F connected non-separating and incompressible or S^2 .

2. By the hypothesis, there exist simple closed curves $\alpha, \beta \subset \partial M$ such that $|\alpha \pitchfork \beta| = 1$. By Corollary 7.6, $[\alpha]$, say, is of infinite order in $H_1(M)$. Therefore, we can choose our epimorphism $\psi : H_1(M) \rightarrow \mathbb{Z}$ such that $\psi[\alpha] \neq 0$. Then we have $F^* = f^{-1}(\star)$ as in (1). Now, $\alpha \bullet \partial F^* = f(\alpha) \bullet \star \neq 0$, since $f_*[\alpha] \neq 0$ in $H_1(S^1) \cong \mathbb{Z}$. Therefore, there exists a component F of F^* such that $\alpha \bullet F \neq 0$. If F is compressible, surger F along a compressing disk to get F' and we have $\alpha \bullet \partial F' = \alpha \bullet \partial F$, as $\partial F = \partial F'$. Therefore there exists a component F'_0 of F' such that $\alpha \bullet F'_0 \neq 0$. Eventually, we get a connected incompressible surface F with $\alpha \bullet \partial F \neq 0$. Therefore $[\partial F] \neq 0$ in $H_1(\partial M)$.

■

Corollary 7.8. *Let M be a compact irreducible 3-manifold with $H_1(M)$ infinite. Then M is Haken. In particular, $\emptyset \neq \partial M \neq \bigsqcup S^2$'s implies that M is Haken.*

Let M be a compact irreducible 3-manifold. Let $h(M)$ denote the maximum number of pairwise disjoint, pairwise non-parallel, closed incompressible surfaces in M . By Theorem 2.6, $h(M)$ is well-defined.

Lemma 7.9. *Let M be a compact irreducible 3-manifold with $\partial M \neq \emptyset$. Let F be an incompressible surface in M such that F is*

- (a) a compressing disk for ∂M , if ∂M is compressible, or
- (b) a connected surface with $[\partial F] \neq 0$ in $H_1(\partial M)$ (as in Lemma 7.7) if ∂M is incompressible.

Then

- (a) $h(M/F) \leq h(M)$ (in fact $h(M/F) = h(M)$ (exercise))
- (b) $h(M/F) < h(M)$.

Proof. 1. Let F_1, F_2, \dots, F_n be a collection of disjoint, non-parallel closed incompressible surfaces in M/F , with $n = h(M/F)$.

- (a) F_1, \dots, F_n are pairwise non-parallel in M . Suppose F_i and F_j are parallel in M . So, there exists $W \subset M$ such that $\partial W = F_i \sqcup F_j$ and $W \cong F_i \times I$. Now, F_i, F_j are not parallel in M/F , and so $W \cap F \neq \emptyset$. Since F is connected, $F \subset W$. But, $\partial F \subset \partial M$, and $W \cap \partial M = \emptyset$.
- (b) F_i is incompressible in M . Exercise. (Suppose not. Let D be a compressing disk for F_i in M . F_i incompressible in M/F implies that $D \cap F \neq \emptyset$. Now use the fact that F is incompressible to obtain a contradiction.)

(a) and (b) imply that $h(M/F) \leq h(M)$.

- 2. Let S be a component of ∂M such that $S \cap \partial F \neq \emptyset$ after being pushed slightly into $\text{int}M$. S is incompressible in M , by hypothesis. Now, $h(M/F) < h(M)$ follows from:

CLAIM: S is not parallel in M to any F_i . Suppose to the contrary. Then there exists a $W \subset M$, $\partial W = S \sqcup F_i$, $W \cong S \times I$, and $S \cap F \neq \emptyset$ by choice of S . So, since F is connected, $F \subset W$. But, $[\partial F] \neq 0$ in $H_1(\partial M)$, hence $[\partial F] \neq 0$ in $H_1(S)$. Therefore, $H_1(S) \rightarrow H_1(W)$ is not injective, contradicting that $W \cong S \times I$.

■

PROOF OF THEOREM 7.1. Let F be an orientable, closed surface in M , F_1, \dots, F_n the components of F . Define $c(F) = \sum_{i=1}^n g(F_i)^2$, where $g(F_i)$ is the genus of F_i . Let F' be obtained from F by surgering along an essential

simple closed curve $\gamma \subset F$. Then $c(F') < c(F)$.

It is enough to prove the Theorem for M Haken with $\partial M \neq \emptyset$. For such M , define $\alpha(M) = (h(M), c(\partial M))$, ordered lexicographically. We proceed by induction on $\alpha(M)$.

$\alpha(M) = (0, 0)$ Therefore $\partial M = \bigsqcup S^2$'s and M irreducible implies that M is a disjoint union of B^3 's.

$\alpha(M) > (0, 0)$ Let F be as in Lemma 7.9. Then, by Lemma 7.9, $\alpha(M/F) < \alpha(M)$. By induction, M/F has a hierarchy. Therefore, M has one too.

EXAMPLE: Let M be a handlebody, F a disjoint union of B^3 's:

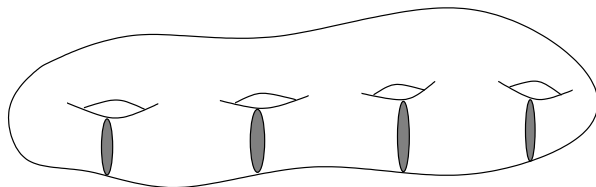

So, M has a hierarchy of length 1 as $M/F = B^3$.

EXERCISE. Every Haken 3-manifold M has a hierarchy of length less than or equal to 3? 4? 2?

Let K be a knot in S^3 , $M_K = S^3 - \text{int}N(K)$ the exterior of K . Now the $\partial M \cong T^2$. $H_1(M) \cong \mathbb{Z}$ is generated by $[\mu]$, μ a meridian of K . Now, we have a map $\pi_1(M) \rightarrow \mathbb{Z}$ induced by $f : M \rightarrow S^1$ such that $f|_{\partial M} \cong S^1 \times S^1$ is projection onto the first factor.

$$\begin{array}{ccc} H_1(M) & \xrightarrow{\cong} & \mathbb{Z} \\ & \nwarrow \quad \nearrow & \\ & \pi_1(M) & \end{array}$$

As before, we get $f^{-1}(\star)$ an orientable incompressible surface F , and ∂F is a copy of the latitude in ∂M , λ . Extending F slightly into $N(K)$ we obtain $F^+ \subset S^3$ with $\partial F^+ = K$. F^+ is a Seifert surface for K .

EXAMPLE. Let K be the trefoil, F as pictured.

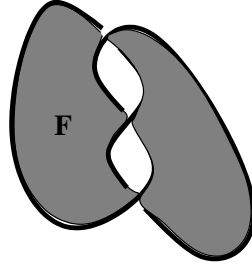

Since $K \neq \bigcirc$, F is an incompressible Seifert surface in M_K as $F \cong T^2 - \overset{\circ}{D}^2$. In this case, M_K is actually an F -bundle over S^1 .

$$M/F \cong S^3 - N(F) \cong S^3 - \Theta \cong H$$

where H is a handlebody of genus two, and by the above example, $H/(D_1 \sqcup D_2) \cong B^3$ where D_1, D_2 are disks as above. So,

$$M, \quad M/F \cong H, \quad H/(D_1 \sqcup D_2) \cong B^3$$

is a hierarchy for M .

EXAMPLE. Let T be a standardly embedded torus in S^3 , $S^3 = V_1 \sqcup V_2$, V_i a solid torus, $i = 1, 2$, and let K be a knot in T . Now, we can choose $N(K)$ such that $N(K) \cap T$ is an annular neighborhood of K in T . Let $A = T - N(K) \cap T$, an annulus. Then $M_K \cong V_1 \cup_A V_2$.

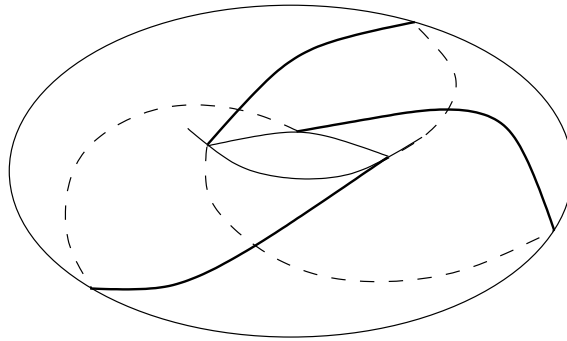

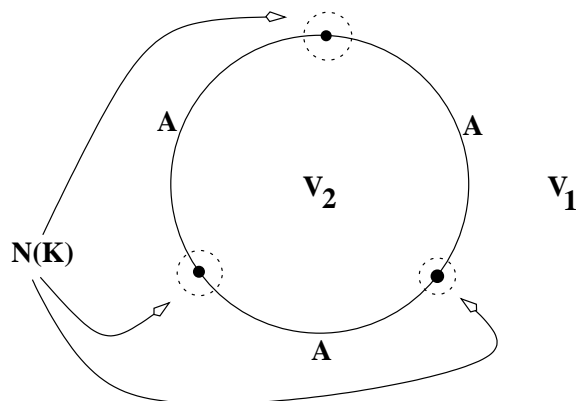

Now, A is incompressible in M_K . (exercise) (In the pictured example, $H_1(A) \rightarrow H_1(V_2)$ is multiplication by 3, and $H_1(A) \rightarrow H_1(V_1)$ is multiplication by 2.)

So,

$$M, \quad M/A = V_1 \sqcup V_2, \quad \bigsqcup V_i/D_i = B_1^3 \sqcup B_2^3$$

is a hierarchy for M .

EXAMPLE. Let K_1, K_2 be knots in S^3 , with exteriors M_1, M_2 . Let $M = M_1 \cup_g M_2$, $g: \partial M_1 \rightarrow \partial M_2$ some gluing homeomorphism, $\partial M_1 = \partial M_2 = T \subset M$. $K_i \neq 0$ implies that ∂M_i is incompressible in M_i . Therefore, T is incompressible in M . M_1, M_2 irreducible, T incompressible implies that M is irreducible. So, M is Haken, and has a hierarchy $M, M/T, \dots$ if g is chosen so that $g(\mu_1) = \lambda_2$, $g(\lambda_1) = \mu_2$. Then, (exercise) $H_1(M) = 0$.

Remarks. M Haken and closed implies that $\pi_1(M)$ is infinite. So, we may pose the question:

If M is a closed irreducible 3-manifold and $\pi_1(M)$ is infinite, is M Haken?

This would be nice!

Answer: NO.

Let K be a knot in S^3 , $M = M_K$. Now, we may perform *Dehn Surgery* on K : Let $M(\alpha) = M \cup_{\partial} V$, V a solid torus, α an essential simple closed curve in ∂M . We glue V and ∂M together in such a way that α is sent to the boundary of a meridian disk of V .

Exercise: $M(\alpha)$ depends only on the isotopy class of α . Also, if $M(\alpha)$ contains an incompressible surface, then either M contains a closed incompressible surface not parallel to ∂M , or α is a boundary slope—i.e.

there exists an incompressible ∂ -incompressible $F \subset M$ with ∂F consisting of copies of α .

EXAMPLE: Let K be the figure eight knot. It can be shown that M does not contain a closed non-boundary-parallel incompressible surface. Now,

Theorem (Hatcher). *For **any** M_K , there exist only finitely many boundary slopes.*

So, for K the figure eight, $M(\alpha)$ does not contain an incompressible surface. Also,

Theorem (Thurston). *The figure eight knot has M_K hyperbolic.*

So, $M(\alpha)$ is hyperbolic for all but finitely many α . So, $M(\alpha) \cong \mathbb{H}^3/\Gamma$, and so the universal cover of $M(\alpha)$ is $\mathbb{H}^3 \cong \mathbb{R}^3$. Therefore, $\pi_1(M(\alpha))$ is infinite and $M(\alpha)$ is irreducible. Hence, for all but finitely many α , $M(\alpha)$ is irreducible, $\pi_1(M(\alpha))$ is infinite, and $M(\alpha)$ is not Haken.

Open Question: Let M be a closed irreducible 3-manifold with $\pi_1(M)$ infinite. Does M have a finite sheeted covering that is Haken?

8 The Disk Theorem

Theorem 8.1 (Disk Theorem, originally stated by Kneser). *Let M be a compact (orientable) 3-manifold, F an incompressible component of ∂M . Then $\pi_1(F) \rightarrow \pi_1(M)$ is injective.*

Remarks.

1. An equivalent statement is: Let M be a compact 3-manifold, F a component of ∂M . If there exists $f : (D^2, \partial D^2) \rightarrow (M, F)$ such that $f|_{\partial D^2} : S^1 \rightarrow F$ is not homotopic to a point, then there exists an embedding $g : (D^2, \partial D^2) \rightarrow (M, F)$ such that $g|_{\partial D^2} \rightarrow F$ is not null-homotopic.
2. The assumption that M is compact is unnecessary (exercise).
3. The Disk Theorem is sometimes called The Loop Theorem-Dehn's Lemma (or The Loop Theorem (inaccurate) or Dehn's Lemma (also inaccurate)), and was first proved by Papakyriakopoulos in 1957. We will give a proof based on one by Johannson (1992) using hierarchies.
4. We can assume that M is irreducible. Let M, F be as in the Disk Theorem. Let S be a maximal independent system of 2-spheres in M . Let M' be the component of M/S that contains F . Let \widehat{M}' denote M' with B^3 's attached along the sphere components of $\partial M'$. Now, \widehat{M}' is irreducible (exercise). Now, since F is incompressible in M , F is incompressible in M' , and so incompressible in \widehat{M}' . If $\pi_1(F) \rightarrow \pi_1(\widehat{M}')$ is injective, then $\pi_1(F) \rightarrow \pi_1(M)$ is injective (exercise, Make $f : D^2 \rightarrow M$ transverse to S , pull back, do a disk exchange.).

Let M be a compact irreducible 3-manifold with $\partial M \neq \emptyset$. Let $M = M_1, \dots, M_n$ with $M_{i+1} = M_i/F_i$, F_i an incompressible, orientable surface in M_i , be a hierarchy for M . Recall that $M_i/F_i \cong \overline{M_i - N(F_i)}$, $N(F_i) \cong F_i \times [-1, 1]$. Let $T_i \subset \partial M_{i+1}$ be the trace of ∂F_i in ∂M_{i+1} , $T_i = \partial F_i \times \{-1, 1\}$.

EXAMPLE. Let $M = V_1 \cup_A V_2$, V_i a solid torus, A the (p_i, q_i) annulus in ∂V_i , $i = 1, 2$, e.g.

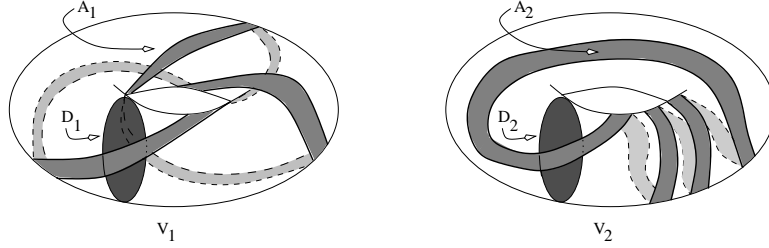

Let $M_1 = M$, $F_1 = A$. Let $M_2 = M/A = V_1 \sqcup V_2$. Then $\Gamma_2 = \partial A_1 \sqcup \partial A_2$.
 Let $F_2 = D_1 \sqcup D_2$. Then let $M_3 = M_2/F_2 = B_1^3 \sqcup B_2^3$, and then Γ_3 looks like:

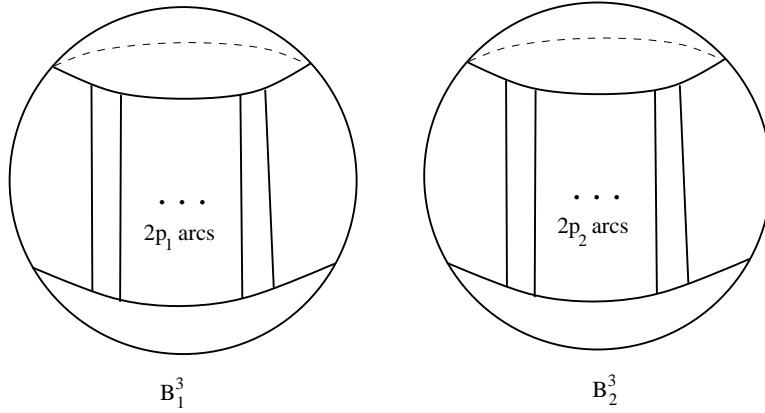

Definition. A hierarchy is *good* if

1. F_i is ∂ -incompressible in M_i ,
2. $|\partial F_i \cap \Gamma_i|$ is minimal among all ∂ -incompressible F_i satisfying (a) or (b) of Lemma 7.9.

Lemma 8.2. *Let M be a compact irreducible 3-manifold, $\partial M \neq \emptyset$. Then M has a good hierarchy.*

Proof. Let F_i be a surface satisfying (a) or (b) of Lemma 7.9. Then, if F_i is ∂ -incompressible, then we are in case (b), and ∂ -compressing F_i yields F'_i with $[\partial F'_i] = [\partial F_i] \in H_1(\partial M_i)$. So, some component of F'_i satisfies (a) or (b). So, we can assume that that F_i is ∂ -incompressible. Now force (2) to hold.

■

Definition. A *Haken 1-complex* in a surface S (possibly with ∂) is a set $\Delta \subset S$ such that Δ is expressed as $\bigcup_{i=0}^n \Delta_i$ where Δ_i is a disjoint union of embedded arcs and circles, each circle is contained either in $\text{int } S$ or ∂S , $\partial \Delta_i \subset \bigcup_{j < i} \overset{\circ}{\Delta}_j$ and meet just so:

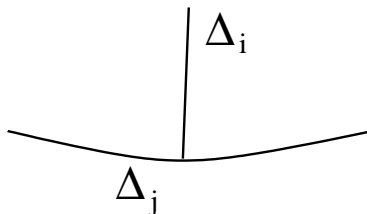

We call n the *depth* of Δ . A *face* of Δ in S corresponds to a component R of $\overline{S - N(\Delta)}$, where $N(\Delta)$ is a “small” neighborhood of Δ . An *edge* of Δ in S is a component of some Δ_i , and is said to have *index* i .

Let M be a compact irreducible 3-manifold, ∂M incompressible in M , with a partial hierarchy. We define a Haken 1-complex (a.k.a. boundary pattern) $\Gamma_i \subset \partial M_i$, $1 \leq i \leq n$, inductively by $\Gamma_1 = \emptyset$, $\Gamma_{i+1} = \Gamma_i \cup T_i$, $1 \leq i < n$, where F_i is chosen so that ∂F_i is transverse to $\Gamma_i \subset \partial M_i$. So, every $x \in \Gamma_i$ has a neighborhood in ∂M_i homeomorphic to either

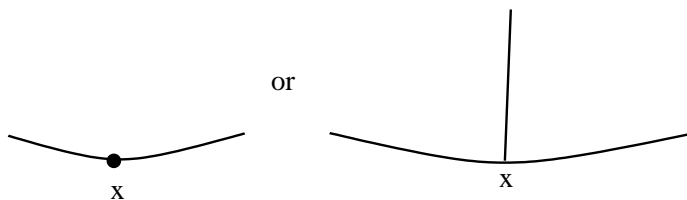

Lemma 8.3. *Each face of Γ_n in ∂M_n is incompressible in M_n .*

Proof. Let \tilde{D} be a disk in M_n with $\partial \tilde{D} \subset \overset{\circ}{R}$, a face of Γ_n . Let \tilde{F}_i denote the trace of F_i in M_n . So, $R \subset \tilde{F}_i$, for some $0 \leq i < n$. So, \tilde{D} gives rise to a disk $D \subset M_i$, with $\partial D \subset F_i$. Now, F_i is incompressible in M_i and therefore ∂D bounds a disk E in F_i . If $E \cap \Gamma_n \neq \emptyset$, then some component of some ∂F_j , $j > i$, lies in E . This contradicts the fact that F_j is either a compressing disk or incompressible. Therefore, $E \subset R$, and so R is incompressible in M_n . ■

Corollary 8.4. *If $M_n \cong \sqcup B^3$'s, then each face of Γ_n in ∂M_n is a disk (or a 2-sphere).*

Lemma 8.5. *Let $M = M_1, \dots, M_n$ be a partial good hierarchy (same as above without assumption that M_n is $\sqcup B^3$'s), with ∂M incompressible. Let D be a properly embedded disk in M_n such that $|\partial D \cap \Gamma_n| = p \leq 3$. Then D is isotopic rel ∂ to a disk $D' \subset \partial M_n$, where D' looks like:*

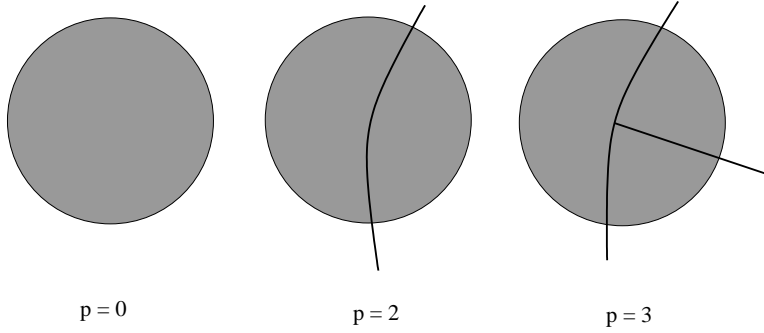

Proof. **p=0** By Lemma 8.3, ∂D bounds a disk $D' \subset R$, where R is the face of Γ_n containing ∂D . Since M_n is irreducible, D is isotopic to D' rel ∂ .

p=1 This case is impossible. Consider the local picture about an arc α in Γ_n containing $\star = \partial D \cap \Gamma_n$. On one side of the arc lies a region $R_i \subset \tilde{F}_i$ and on the other, $R_j \subset \tilde{F}_j$, $i \neq j$. So, $\partial D/\star$ must be contained in R_i and R_j , which is impossible.

p=2 Let $\varepsilon, \varepsilon'$ be the edges of Γ_n containing the two points of $\partial D \cap \Gamma_n$. Let α, β be the two arcs in ∂D with $\partial\alpha = \partial\beta = \partial D \cap \Gamma_n$. Now, $\varepsilon \subset T_i$, $\varepsilon' \subset T_j$, say. Suppose $i < j$. Then $\partial D \subset \partial M_{j+1}$ and meets T_j in one point, a contradiction. So, $i = j$. Now, we have the following picture:

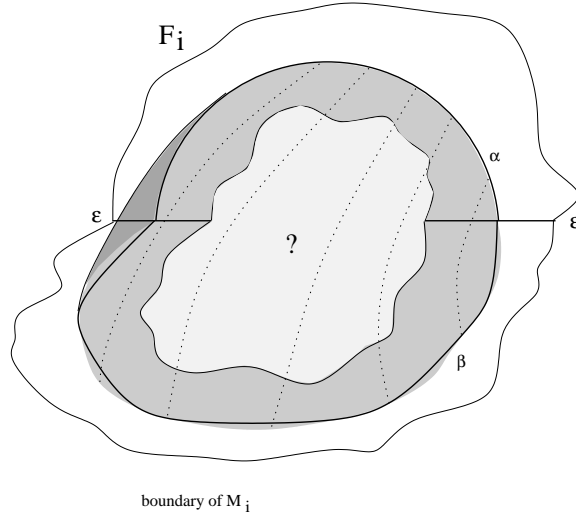

Since F_i is ∂ -incompressible in M_i , there exists a disk $E \subset F_i$ with $\partial E = \alpha \cup \gamma$, $\gamma = \partial E \cap \partial M_i$.

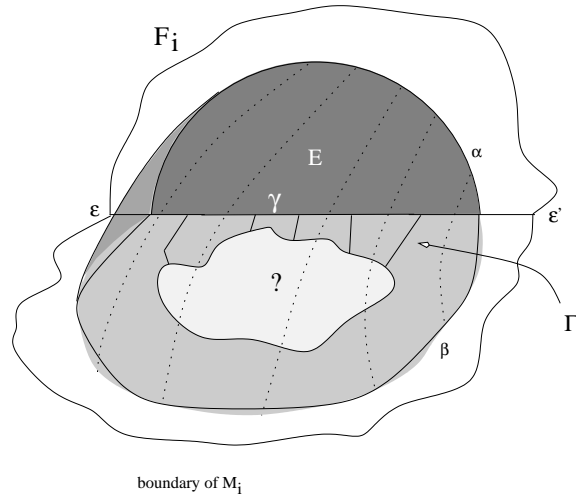

Case I: F_i is a disk Boundary compress F_i along D to obtain F'_i, F''_i . Now, one of F'_i, F''_i is a compressing disk for ∂M . So, we can't have $|\gamma \cap \Gamma_i| \neq 0 \neq |\gamma'' \cap \Gamma_i|$, by the minimality of $|\partial F_i \cap \Gamma_i|$. Therefore, $\gamma \cap \Gamma_i = \emptyset$, say. Therefore, $\beta \cup \gamma$ is contained in a region of Γ_i , say $R \subset \partial M_i$, and bounds a disk, (essentially $D \cup E$). Therefore, by Lemma 8.3, $\beta \cup \gamma = \partial E'$, E' a disk in R .

Let $D' = E \cup E'$, $(\Gamma_n \cap \text{int } D') = \emptyset$. Now, $D \cup D'$ is the boundary of a 3-ball in M_n and so D is isotopic in M_n to D' as desired.

Case II: F_i is not a disk If $\gamma \cap \Gamma_i \neq \emptyset$, then $F'_i = (F_i - E) \cup D$ is incompressible and ∂ -incompressible (exercise) and $|\partial F'_i \cap \Gamma_i| < |\partial F_i \cap \Gamma_i|$. Now, $[\partial F_i] = [\partial F'_i] + [\partial F''_i] \in H_1(\partial M_i)$. But, F''_i is a disk. Therefore, (since we are in situation (b)), $\partial F''_i$ bounds a disk in ∂M_i . Therefore, $[\partial F'_i] = [\partial F_i] \neq 0$, and this contradicts our choice of F_i . Therefore, $\gamma \cap \Gamma_i = \emptyset$. Now, the rest of the argument follows as in Case I.

$p=3$

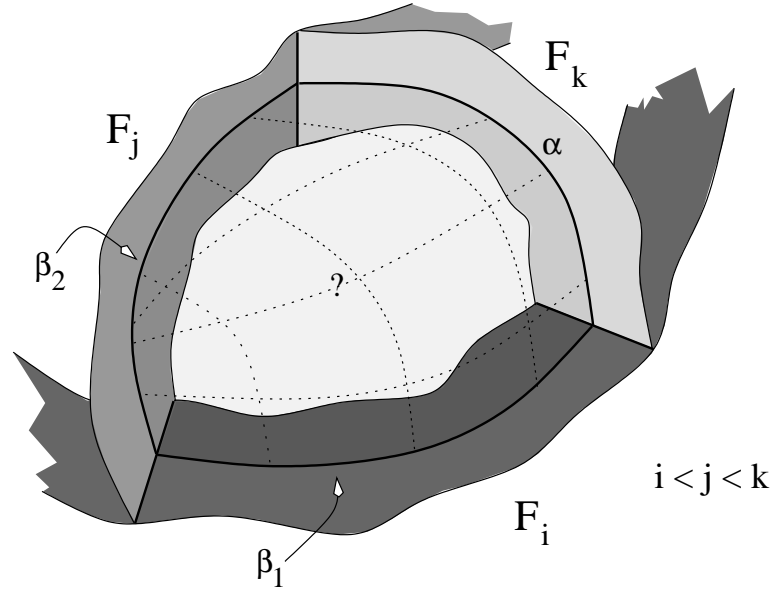

Let $\beta = \beta_1 \cup \beta_2 \subset \partial M_k$. Now, F_k ∂ -incompressible in M_k implies that there exists a disk $E \subset F_k$ such that $\partial E = \alpha \cup \gamma$, $\gamma = E \cap \partial M_k$.

If $\gamma \cap \Gamma_k = \emptyset$, then $\beta \cup \gamma$ is a simple closed curve in ∂M_k meeting Γ_k in one point, a contradiction. Therefore, $|\gamma \cap \Gamma_k| \geq 1$.

Suppose $|\gamma \cap \Gamma_k| > 1$, then as in the case $p = 2$, we get F'_k with $|\partial F'_k \cap \Gamma_k| < |\partial F_k \cap \Gamma_k|$, and F'_k still satisfies our minimality conditions (exercise). So, $|\gamma \cap \Gamma_k| = 1$.

Now, $\beta \cup \gamma = \partial(D \cup E)$ and $|(\beta \cup \gamma) \cap \Gamma_k| = 2$. Now we reduce to the case $p = 2$ to obtain disks $E_1 \subset F_i$, $E_2 \subset F_j$ that look like:

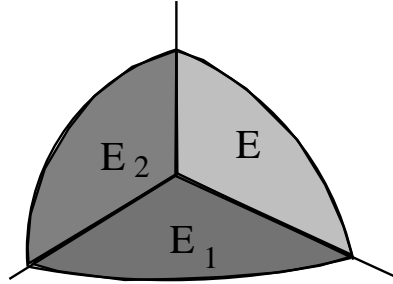

Now, $D' = E \cup E_1 \cup E_2$ is the desired disk.



Corollary 8.6. *Suppose $M_n \cong \sqcup B^3$'s and γ is a simple closed curve in ∂M_n such that $|\gamma \cap \Gamma_n| = p \leq 3$. Then γ bounds a disk $D' \subset \partial M_n$ as in Lemma 8.5.*

Proof. $M_n \cong \sqcup B^3$'s and so $\gamma = \partial D$, D a disk in M_n . Now apply Lemma 8.5.



Lemma 8.7. *Suppose $M_n \cong \sqcup B^3$'s, δ a loop in ∂M_n such that $|\delta \cap \Gamma_n| = p \leq 3$. Then δ looks like:*

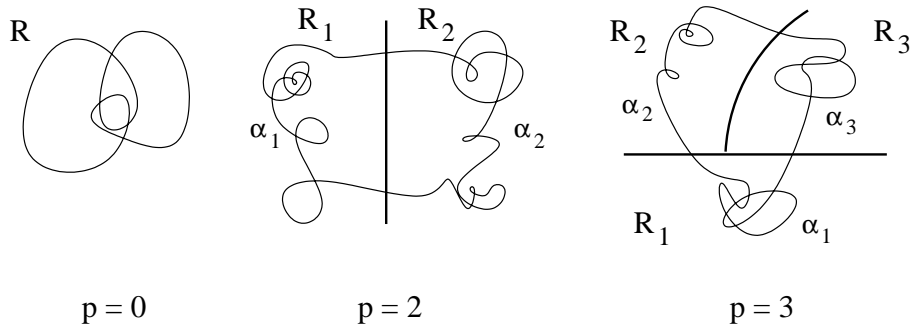

Proof. $M_n \cong \sqcup B^3$'s implies that each face of Γ_n is a disk.

$p = 0$ Clear.

$p = 2$ $\delta = \alpha_1 \cup \alpha_2$, α_i an arc (not necessarily embedded) contained in a disk face R_i . Now, each α_i is homotopic *rel* ∂ to β_i , an embedded arc in R_i . Now, $\gamma = \beta_1 \cup \beta_2$ is an embedded loop with $|\gamma \cap \Gamma_n| = 2$. The result now follows from Lemma 8.6.

$p = 3$ (exercise, similar to $p = 2$)



Definition. Let $\Delta \subset D^2$ be a Haken 1-complex with $\partial D^2 \subset \Delta$, $\Delta = \bigcup_{i=0}^n \Delta_i$ with $\Delta_0 = \partial D^2$. The *order* of a face R of Δ is the number of *corners* in ∂R :

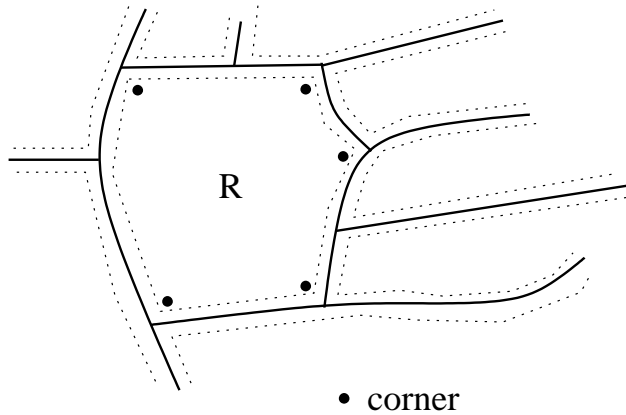

A p -gon of Δ is a face of order p . An *elementary reduction cell* D for Δ is a p -gon of Δ , $p = 0, 2, 3$:

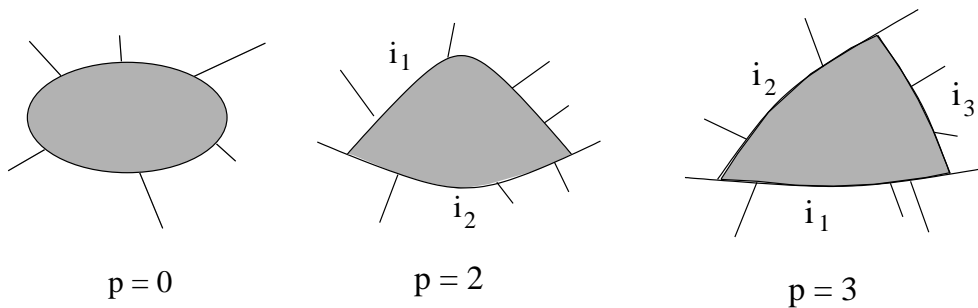

A *reduction cell* D for Δ is a p -gon face of a Haken subcomplex of Δ , $p = 0, 2, 3$:

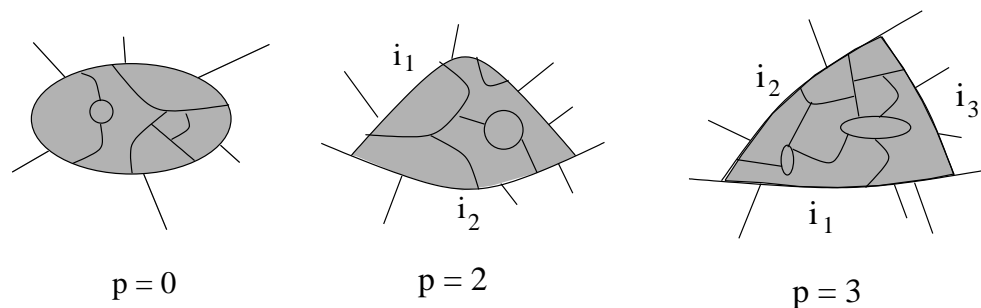

Lemma 8.8. *Let Δ be a Haken 1-complex in D^2 . The Δ has a face of order 0, 2, 3.*

Proof. We proceed by induction of the number of edges of Δ .

1 edge Here $\Delta = \Delta_0 = \partial D^2$, and we're done.

more than 1 edge Let ε be an edge of maximal index. Then $\Delta' = \overline{\Delta - \varepsilon}$ is a Haken 1-complex. By induction, Δ' has a face D of order 0, 2, 3. If $\varepsilon \not\subset D$, then D is a face of Δ . If $\varepsilon \subset D$, then ε determines a face of E of Δ of order 0, 2, 3, $E \subset D$:

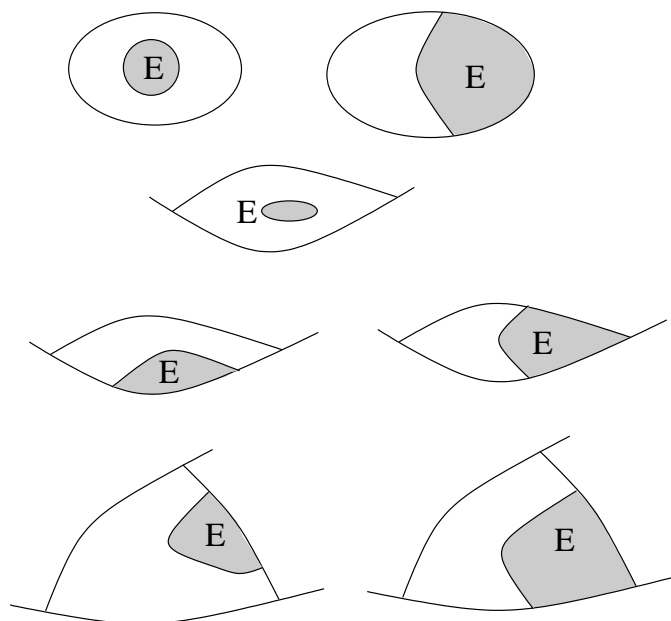

et cetera



Remarks. Let M be a compact irreducible 3-manifold, $\partial M \neq \emptyset$ incompressible. Our goal is to show that $\pi_1(\partial M) \rightarrow \pi_1(M)$ is injective, i.e. and $f : (D^2, \partial D^2) \rightarrow (M, \partial M)$ has $f|_{\partial D^2} \simeq \star$ in ∂M .

Let $M = M_1, M_2, \dots, M_{n+1} \cong \bigsqcup B^3$'s be a good hierarchy with $M_{i+1} = M_i/F_i$, $1 \leq i \leq n$, $F_0 = \partial M$. Let $X = \bigcup_{i=0}^n F_i \subset M$. By a small homotopy, make f transverse to X . Then, $f^{-1}(X) = \Delta$ is a Haken 1-complex in D^2 with $\Delta_i = f^{-1}(F_i)$. In particular, $\Delta_0 = \partial D^2$.

Definition. Let Δ be a Haken 1-complex in D^2 as above. Let D be a reduction cell for Δ . Let $N(D)$ be a regular neighborhood of D in D^2 , thus

$$(\overline{\Delta - D} \cap N(D)) \cong ((\overline{\Delta - D}) \cap \partial D) \times I$$

We say that a Haken 1-complex Δ' is *obtained from Δ by a reduction along D* and write $\Delta \xrightarrow{D} \Delta'$, if:

1. $\Delta' = \Delta$ outside $N(D)$
2. In $N(D)$, Δ' is as follows:

$p = 0$ Every edge of Δ' that meets $N(D)$ has index greater than i :

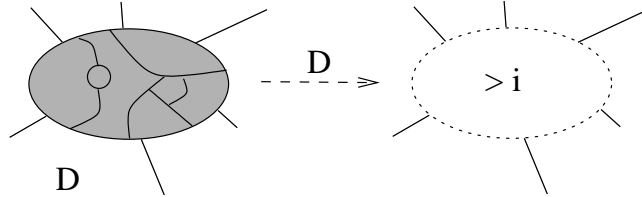

$p = 2$

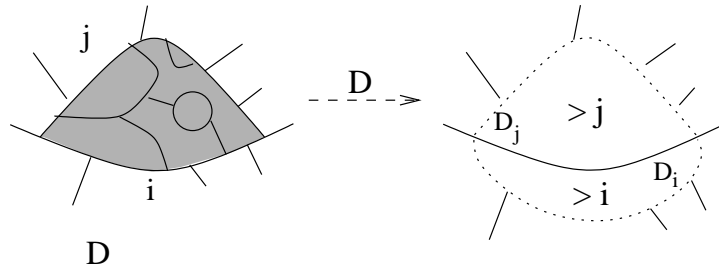

The edge of index i separates $N(D)$ into two disk D_i, D_j as shown. Then every edge of Δ' that meets D_j has index greater

than j , and every edge of Δ' that meets D_i has index greater than i , and the original edge of index j disappears.

$p = 3$

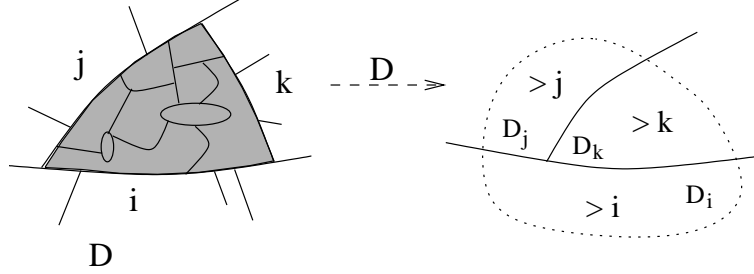

The edges of index i and j separate $N(D)$ into three disks D_i, D_j, D_k . Then every edge of Δ' that meets D_i has index greater than i , every edge of Δ' that meets D_j has index greater than j , every edge of Δ' that meets D_k has index greater than k , and the edge of index k disappears.

Note: We allow $D \cap \partial D^2 \neq \emptyset$, in which case $D_i = \emptyset$. The motivation for this definition is the following. Let M be a compact irreducible 3-manifold, ∂M incompressible. We have a good hierarchy

$M = M_1, M_2, \dots, M_{n+1} = \bigsqcup B^3$'s, $M_{i+1} = M_i/F_i$, $F_0 = \partial M$. Let $X = \bigsqcup_{i=0}^n F_i =$ "Haken 2-complex" in M . We also have a map of pairs, $f : (D^2, \partial D^2) \rightarrow (M, \partial M)$. By a small homotopy of pairs, make f transverse to X . Then $f^{-1}(X) = \Delta$ is a Haken 1-complex in D^2 , $\Delta_i = f^{-1}(F_i)$. Now, fix $f_0 : (D^2, \partial D^2) \rightarrow (M, \partial M)$, and let $\mathfrak{F} = \{\Delta = f^{-1}(X) \mid f : (D^2, \partial D^2) \rightarrow (M, \partial M), f \simeq f_0 \text{ as pairs}\}$

Lemma 8.9. *Suppose $\Delta \in \mathfrak{F}$, $\Delta \neq \Delta_0$. let D be an elementary reduction cell for Δ . Then there exists $\Delta' \in \mathfrak{F}$ such that $\Delta \xrightarrow{D} \Delta'$.*

Proof. $p = 0$ Define a function g by $g = f$ outside $N(D)$, and on $N(D)$, g is obtained by "pushing $f(D)$ into, and then slightly off of, F_i ." Now, let $\Delta' = g^{-1}(X)$ and then $\Delta' \in \mathfrak{F}$ and $\Delta \xrightarrow{D} \Delta'$.

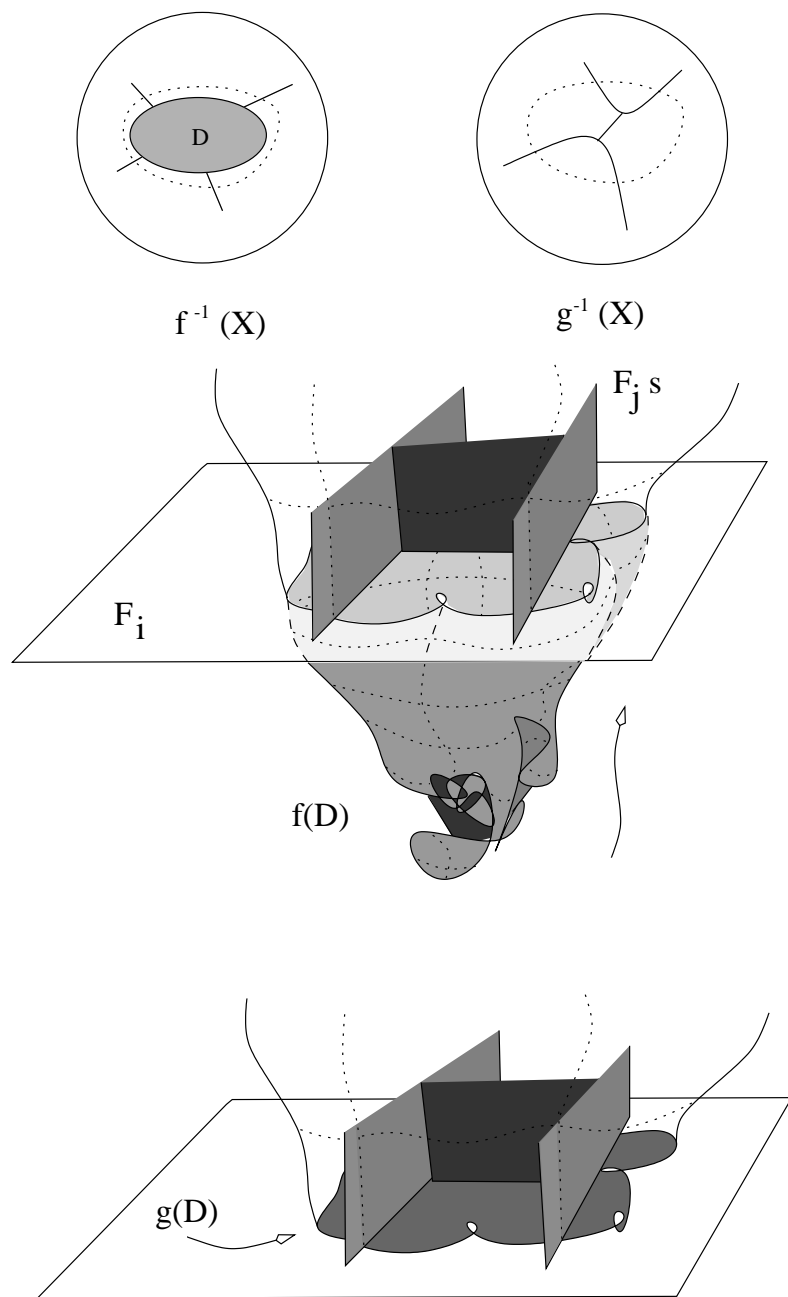

$p = 2$ By Lemma 8.7, $f(D)$ looks like:

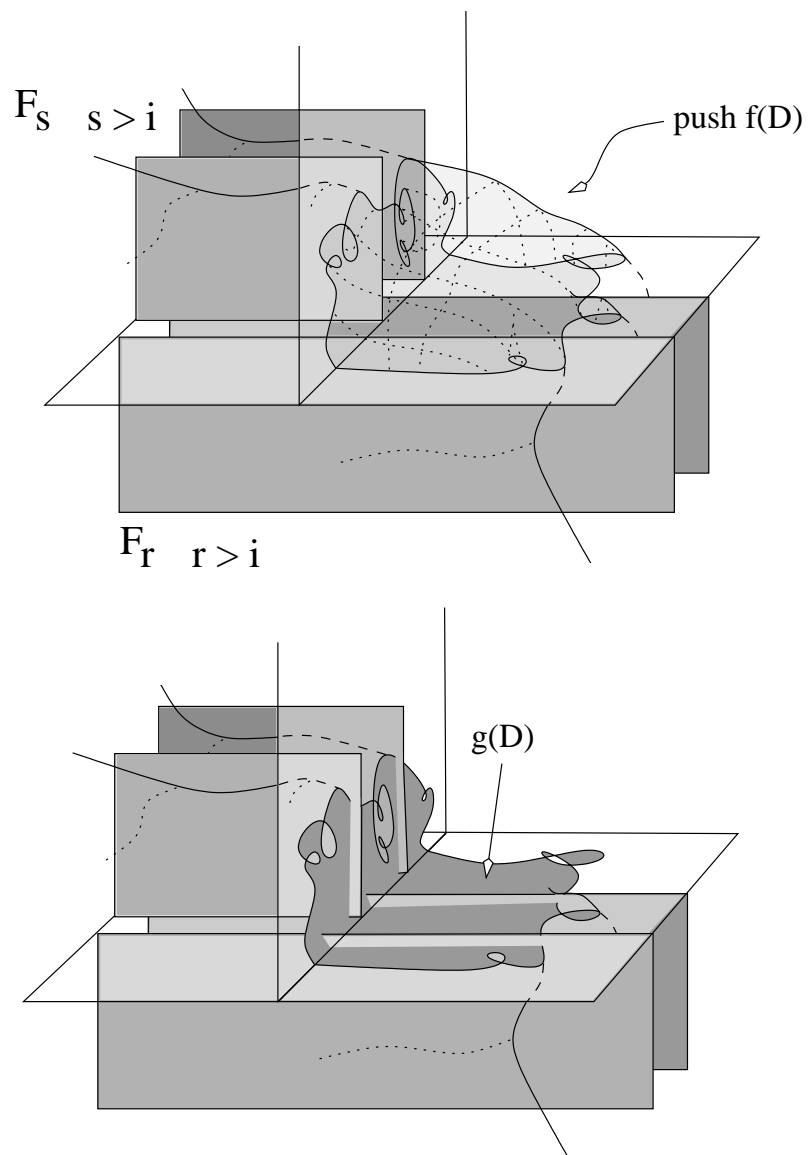

Define $g \simeq f$ as maps of pairs by “pushing $f(D)$ through $F_i \cup F_j$,” and let $\Delta' = g^{-1}(X)$.

$p = 3$ Exercise.

■

Call Γ a *subgraph* of Δ , i.e. a union of edges of Δ (not necessarily a subcomplex). Let $\alpha_i(\Gamma) = \#$ of edges of Γ of index i . Define $c(\Gamma) = (\alpha_1(\Gamma), \alpha_2(\Gamma), \dots, \alpha_n(\Gamma))$, lexicographically ordered. Let D be a reduction cell for Δ , and define Δ_D to be the subgraph of Δ : $\Delta_D = \overline{\Delta \cap \text{int}D}$, e.g.

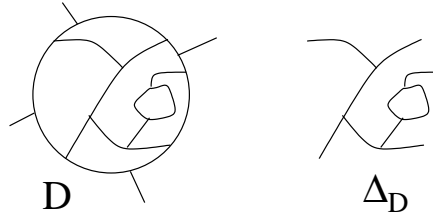

Let ε be an edge of Δ , $\varepsilon \subset D$, $\partial\varepsilon = \partial D$. Then ε determines (at least one) reduction cell E for Δ , $E \subsetneq D$.

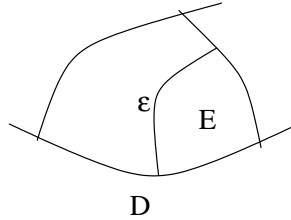

Lemma 8.10. Suppose $\Delta \xrightarrow{E} \Delta'$. Then $c(\Delta'_D) < c(\Delta_D)$.

Proof.

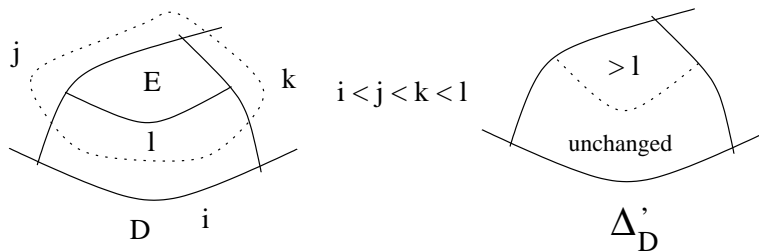

Now, $\alpha_r(\Delta'_D) \leq \alpha_r(\Delta_D)$, $r \leq l$, $\alpha_l(\Delta'_D) < \alpha_l(\Delta_D)$. Therefore, $c(\Delta'_D) < c(\Delta_D)$.

■

Note: Take $D = D^2$. Then $\Delta_{D^2} = \overline{\Delta - \Delta_0}$ and $c(\Delta_{D^2}) = c(\Delta)$.

Lemma 8.11. *Suppose $\Delta \in \mathfrak{F}$, and let D be a reduction cell for Δ . Then there exists $\Delta' \in \mathfrak{F}$ such that $\Delta \xrightarrow{D} \Delta'$.*

Proof. We proceed by induction on $c(\Delta_D)$. Suppose $c(\Delta_D) = 0 = (0, \dots, 0)$. Then D is an elementary reduction cell and by Lemma 8.9, we are done. Now, suppose $c(\Delta_D) > 0$. So, there exists an edge $\varepsilon \subset D$, $\partial\varepsilon \subset \partial D$ which gives rise to a reduction cell $E \subsetneq D$. Clearly, $c(\Delta_E) < c(\Delta_D)$. Therefore, by induction, there exists $\Delta'' \in \mathfrak{F}$ such that $\Delta \xrightarrow{E} \Delta''$. By Lemma 8.10, $c(\Delta''_D) < c(\Delta_D)$. Once again, by induction, there exists $\Delta' \in \mathfrak{F}$ such that $\Delta'' \xrightarrow{D} \Delta'$. Now, $\Delta \xrightarrow{D} \Delta'$, for:

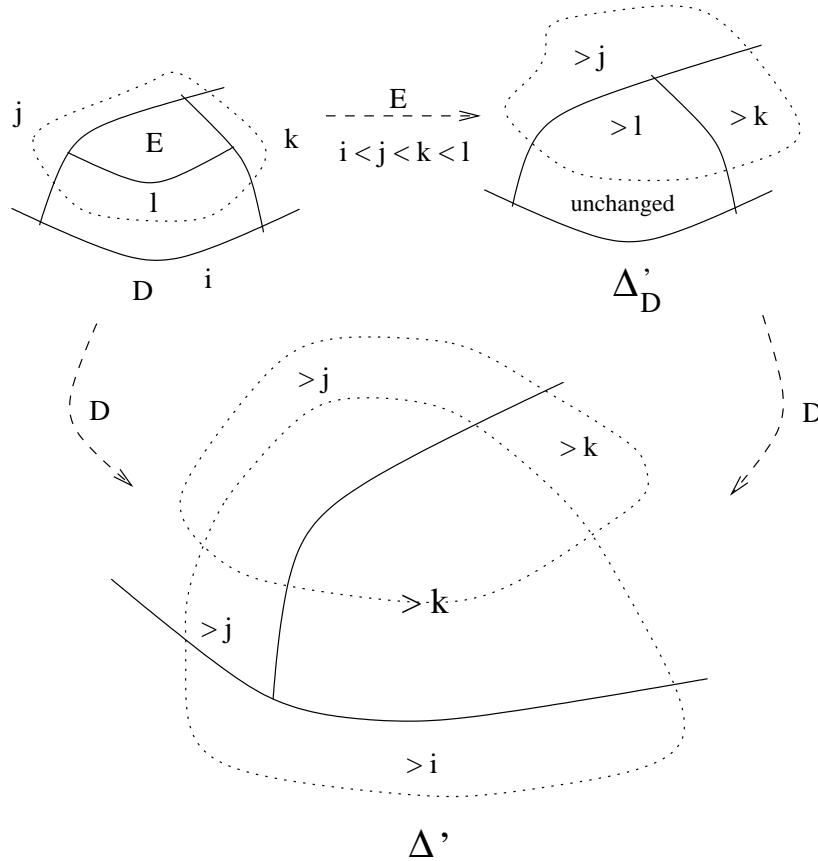

■

PROOF OF THE DISK THEOREM: Pick $f_0 : (D^2, \partial D^2) \rightarrow (M, \partial M)$. We will show that $f_0|_{\partial D^2} \simeq \star$. Choose $\Delta \in \mathfrak{F}$ with $c(\Delta)$ minimal.

$c(\Delta) = 0$ Then $f_0 \simeq f$ as maps of pairs with $f(D^2) \cap (\bigcup_{i=1}^n F_i) = \emptyset$.
 Therefore, $f(\partial D^2) \subset R \cong D^2$, a face of $\Gamma_{n+1} \subset \partial M_{n+1}$. Therefore,
 $f|_{\partial D^2} \simeq \star \in \partial M$.

$c(\Delta) > 0$

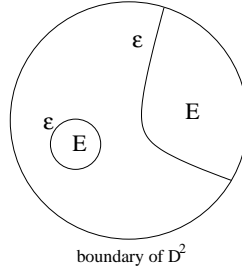

Then there exists an edge ε of Δ with $\partial\varepsilon \subset \partial D^2$. So, ε defines a reduction cell E (of order 0 or 2) for Δ . By Lemma 8.11, there exists $\Delta' \in \mathfrak{F}$ such that $\Delta \xrightarrow{E} \Delta'$. By Lemma 8.10,
 $c(\Delta') = c(\Delta'_{D^2}) < c(\Delta_{D^2}) = c(\Delta)$, contradicting the minimality of $c(\Delta)$.

■

Now, the Disk Theorem and hierarchies can be used to show:

Theorem (Waldhausen, 1970). *Let M be a Haken 3-manifold. Then $\pi_1(M)$ has solvable word problem.*

For arbitrary 3-manifolds, this remains open.

The Disk Theorem also implies:

Theorem (Loop Theorem). *Let F be a component of ∂M , M a compact 3-manifold with $\pi_1(F) \rightarrow \pi_1(M)$ not injective. Then there exists a simple loop $\gamma \subset F$ such that $[\gamma] \neq 1 \in \pi_1(F)$, but $[\gamma] \mapsto 1 \in \pi_1(M)$.*

Problems.

1. (Nothing to do with topology). Consider the following *semigroups* S given by generators and relations. The elements of S are equivalence classes of *words* in the generators (e.g. $aabcddeaabbc$), where two words are *equivalent* (represent equal elements of S) iff one can be obtained from the other by a finite sequence of *substitutions* using the given relations, i.e. if $r_1 = r_2$ is a relation, then, in a word which contains r_1 as a subword, r_1 may be replaced by r_2 .
E.g. in the third example:

$$abcd = acbd = cabd = cdb = cd.$$

In each case, find an algorithm to solve the *word problem* in S , i.e., to decide whether or not two given words are equivalent.

- (a) $|a, b : ab = ba|$
 (b) $|a, b, c, d : ac = ca, ad = da, bc = cb, bd = db|$
 (c) $|a, b, c, d : ac = ca, ad = da, bc = cb, bd = db, ca = c, db = d|$
 (d) $|a, b, c, d, e : ac = ca, ad = da, bc = cb, bd = db, eca = ce, edb = de, cca = ccae|$
2. Let S be a listable set, and let \sim be an equivalence relation of S . The elements of S can be classified up to \sim iff there exists a listable set $S' \subset S$ such that S' contains exactly one element from each \sim class. The \sim problem is solvable iff there is an algorithm to decide whether or not two given elements of S are \sim .
- (a) Show that if the \sim problem is solvable then the elements of S can be classified up to \sim .
 (b) What about the converse?
 (c) What about the converse in the case where S is the set of closed PL n -manifolds and \sim is PL homeomorphism?
3. Let $P = \langle X : R \rangle$ be a finite presentation of a group G . Let W be the set of words in X and let $T = \{w \in W : w = 1\} \subset W$.
- (a) Show that T is listable.

- (b) Show that the decidability of T depends only on G .
4. Let P be the presentation $\langle a, b : aba = bab, a^2 = b^3 \rangle$. Find a sequence of Tietze transformations taking P to the empty presentation $\langle \emptyset : \emptyset \rangle$ (of the trivial group).
 5. Let F be a surface in a closed 3-manifold M . Show that F is incompressible iff each component of F is incompressible.
 6. Let $S^2 \tilde{\times} S^1$ be the *twisted S^2 -bundle over S^1* , i.e. the identification space $S^2 \times I / \{(\alpha(x), 0) \forall x \in S^2\}$, where $\alpha : S^2 \rightarrow S^2$ is the antipodal map. (Note that $S^2 \times S^1$ has an analogous description with α replaced by the identity map.) Prove
 - (a) $S^2 \times S^1$ and $S^2 \tilde{\times} S^1$ are prime;
 - (b) M irreducible implies that M is prime;
 - (c) M prime implies that M is irreducible or homeomorphic to $S^2 \times S^1$ or $S^2 \tilde{\times} S^1$.
 7. Let F be a 2-sided incompressible surface in a closed 3-manifold M . Show that M is irreducible iff M/F is irreducible. What if F is 1-sided?
 8. Show that uniqueness of prime factorization for closed 3-manifolds is false in general. (Hint: consider $S^2 \times S^1$ and $S^2 \tilde{\times} S^1$.)
 9. Let K be a knot in S^3 and let $M_K = S^3 - \text{int}N(K)$. Show that M_K is irreducible. What about links $L \subset S^3$?
 10. Show that a handlebody is irreducible.
 11. Let M be an irreducible 3-manifold which contains a 1-sided P^2 . Show that M is homeomorphic to P^3 .
 12. Let $\tilde{M} \rightarrow M$ be a covering projection of 3-manifolds. Show
 - (a) M irreducible $\Rightarrow \tilde{M}$ irreducible
 - (b) \tilde{M} irreducible $\Rightarrow M$ irreducible.

Give an example where \tilde{M} is prime but M is not.

13. Give an example of a closed 3-manifold M with $\pi_1(M)$ finite such that M contains an incompressible surface.
14. Let M be a closed 3-manifold, and $S \subset M$ a 2-sphere, realizing M as a connected sum $M_1 \# M_2$. Show that if $\pi_1(M) \neq 1, i = 1, 2$, then $[S] \neq 0 \in \pi_2(M)$.
15. A link L in S^3 is *split* if there is a 2-sphere $S \subset S^3 - L$, separating S into two 3-balls B_1 and B_2 , such that $L \cap B_i \neq \emptyset, i = 1, 2$. Show that there is an algorithm to decide whether or not a given link in S^3 is split.
16. Show that, assuming the Rubinsteing algorithm for recognizing S^3 , there is an algorithm to decide whether or not a given compact 3-manifold is a handlebody.
17. Use the theory of normal 1-manifolds in surfaces to show that $\mathbb{R}P^2$ contains a unique essential simple closed curve, up to isotopy.
18. Show that for each $g \geq 1$, there is an algorithm to decider whether or not a given closed irreducible 3-manifold M contains a closed incompressible orientable surface of genus $\leq g$. What about genus $= g$?
19. Every knot K in S^3 bounds an orientable surface F . The *genus* of K is the minimal genus of such a surface. (Thus K is trivial iff genus $K = 0$.) Show that there is an algorithm to compute the genus of a knot.
20. Let M be a closed triangulated 3-manifold. A *maximal system* of normal 2-spheres in M is a normal surface S in M such that
 - (a) each component of S is a 2-sphere;
 - (b) no two components of S are *normally parallel* (i.e. correspond to the same vector $x \in \mathbb{Z}_+^n$);
 - (c) if S_0 is a normal 2-sphere in M disjoint from S , then S_0 is normally parallel to some component of S .

Show that such a system may be constructed algorithmically in any 3-manifold M that does not contain a projective plane.

21. Let M be a 3-manifold with boundary, and let S be a 2-sphere in $\text{int } M$. Show that a simple closed γ in ∂M bounds a disk in M iff it bounds a disk in M/S .
22. Let F be a connected, incompressible, boundary-incompressible surface in a handlebody. Show that F is a disk.
23. Let F be a surface properly embedded in a 3-manifold M , and let F' be obtained from F by boundary surgery along a disk. Show that F incompressible implies F' incompressible.
24. Let F be a connected incompressible surface in a 3-manifold M such that ∂F is contained in a torus component of ∂M . Show that, if F is not an annulus, then F is boundary-incompressible.
25. Let M be a compact, irreducible, triangulated 3-manifold. Show that if M contains an incompressible torus, then it contains one that is either fundamental or ∂N (fundamental Klein bottle).
26. Let M be any manifold. The *double* of M is $dM = M \cup_g M'$, where M' is a copy of M , and $g : \partial M \rightarrow \partial M'$ is the identity map. Let M be a 3-manifold with ∂M incompressible, and let $F \subset M$ be a properly embedded surface. Show that F is incompressible and boundary-incompressible in M iff dF is incompressible in dM .
27. For any diagram D of the unknot, let $\rho(D)$ be the least number of Reidemeister moves required to transform D to the trivial diagram (with no crossings). Define $f : \mathbb{Z}_+ \rightarrow \mathbb{Z}_+$ by

$$f(n) = \max\{\rho(D) : D \text{ a diagram of the unknot with } n \text{ crossings}\}.$$

Show that f is a computable function.

28. Let M be a closed 3-manifold, having a triangulation with t 3-simplices. Since, for a given t , there are only finitely many such manifolds M , there is a function $f : \mathbb{N} \rightarrow \mathbb{N}$ such that $\dim H_1(M; \mathbb{Z}_2) \leq f(t)$. Find an explicit such function f .
29. Assuming Alexander's (3-dimensional Schoenflies) Theorem and Dehn's Lemma, show that every torus in S^3 bounds a solid torus.

30. Let $M \subset S^3$ be a connected compact 3-manifold with ∂M a disjoint union of k tori. Show that there is a k -component link L in S^3 such that M is homeomorphic to $S^3 - \text{Int}N(L)$.
31. Can you find an example of M as in the previous exercise such that not all components of $S^3 - \text{Int}M$ are solid tori? Such that no component of $S^3 - \text{Int}M$ is a solid torus?
32. Let M be a compact 3-manifold with ∂M a torus, and let $\widehat{M} = M \cup V$, where V is a solid torus, glued along their boundaries. Assume that \widehat{M} is irreducible. Let \widehat{F} be a closed incompressible surface in \widehat{M} , isotoped so that $\widehat{F} \cap V$ consists of $n \geq 0$ meridian disks of V , where n is minimal. Show that $F = \widehat{F} \cap M$ is incompressible and ∂ -incompressible in M .
33. Let P be a compact, connected *planar surface*, i.e. a 2-sphere with the interiors of a finite (non-zero) number of disjoint disks removed. Let $P = P_1, \dots, P_n$ be such that $P_{i+1} = P_i/\alpha_i$, where α_i is an essential arc in P_i , $1 \leq i < n$, and P_n is a disjoint union of disks. Show that if P is not a disk then $|P_n| < |\partial P|$.
34. Let M be a handlebody of genus 2. Can you find a connected, orientable, incompressible surface F (with boundary) in M , other than a disk? If F is such a surface, what can you say about $\chi(F)$? About $|\partial F|$?